

JVC

SERVICE MANUAL

TWIN-CD PORTABLE SYSTEM

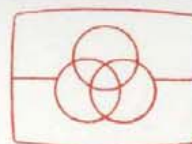

Free service manuals
Gratis schema's

Digitized by

PC-XT3 B/E/G

www.freeservicemanuals.info



COMPACT
disc
DIGITAL AUDIO

Area suffix

B U.K.
E Continental Europe
G Germany

Contents

	Page		Page
1 Safety Precautions	2	9 Block Diagram	41
2 Safety Precautions about PC-XT3	3	10 Wiring Connections	43
3 Features	5	11 Standard Schematic Diagram and Location of P.C. Board Part	44
4 Specifications	5	12 Electrical Parts List	52
5 Instructions (Extract)	6	13 Illustration of Packing and Packing Parts List	58
6 Location of Main Parts	17	14 Accessories	59
7 Removal of Main Parts and Enclosure Parts List ..	19		
8 Main Adjustment	28		

1 Safety Precautions

1. The design of this product contains special hardware and many circuits and components specially for safety purposes. For continued protection, no changes should be made to the original design unless authorized in writing by the manufacturer. Replacement parts must be identical to those used in the original circuits. Service should be performed by qualified personnel only.
2. Alterations of the design or circuitry of the product should not be made. Any design alterations of the product should not be made. Any design alterations or additions will void the manufacturer's warranty and will further relieve the manufacturer or responsibility for personal injury or property damage resulting therefrom.
3. Many electrical and mechanical parts in the product have special safety-related characteristics. These characteristics are often not evident from visual inspection nor can the protection afforded by them necessarily be obtained by using replacement components rated for higher voltage, wattage, etc. Replacement parts which have these special safety characteristics are identified by (Δ) on the schematic diagram and Parts List in Service Manual. The use of a substitute replacement which does not have the same safety characteristics as the recommended replacement part shown in the Parts List in Service Manual may create shock, fire, or other hazards.
4. The leads in the products are routed and dressed with ties, clamps, tubings, barriers and the like to be separated from live parts, high temperature parts, moving parts and/or sharp edges for the prevention of electric shock and fire hazard.

When service is required, the original lead routing and dress should be observed, and it should be confirmed that they have been returned to normal, after re-assembling.

5. Leakage current check (Electrical shock hazard testing)

After re-assembling the product, always perform an isolation check on the exposed metal parts of the product (antenna terminals, knobs, metal cabinet, screw heads, headphone jack, control shafts, etc.) to be sure the product is safe to operate without danger of electrical shock.

Do not use a line isolation transformer during this check.

- Plug the AC line cord directly into the AC outlet. Using a "Leakage Current Tester", measure the leakage current from each exposed metal part of the cabinet, particularly any exposed metal part having a return path to the chassis, to a known good earth ground. Any leakage current must not exceed 0.5 mA AC (r.m.s.).

• Alternate check method

Plug the AC line cord directly into the AC outlet. Use an AC voltmeter having 1,000 ohms per volt or more sensitivity in the following manner. Connect a 1,500 Ω 10 W resistor paralleled by a 0.15 μ F AC-type capacitor between an exposed metal part and a known good earth ground.

Measure the AC voltage across the resistor with the AC voltmeter.

Move the resistor connection to each exposed metal part, particularly any exposed metal part having a return path to the chassis, and measure the AC voltage across the resistor. Now, reverse the plug in the AC outlet and repeat each measurement. Any voltage measured must not exceed 0.75 V AC (r.m.s.).

This corresponds to 0.5 mA AC (r.m.s.).

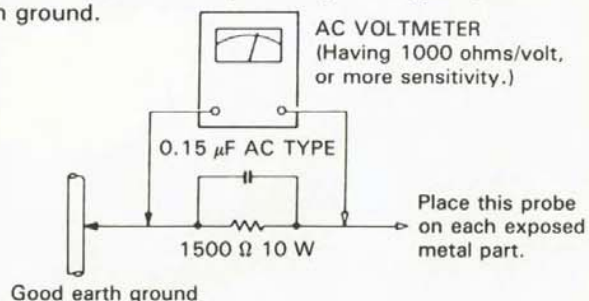

Warning

1. This equipment has been designed and manufactured to meet international safety standards.
2. It is the legal responsibility of the repairer to ensure that these safety standards are maintained.
3. Repairs must be made in accordance with the relevant safety standards.
4. It is essential that safety critical components are replaced by approved parts.
5. If mains voltage selector is provided, check setting for local voltage.

IMPORTANT (In the United Kingdom) Mains Supply (AC 240 V \sim , 50 Hz only)

IMPORTANT

Do not make any connection to the Larger Terminal coded E or Green. The wires in the mains lead are coloured in accordance with the following code:

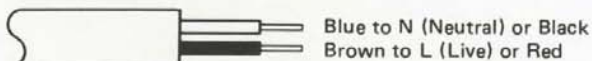

If these colours do not correspond with the terminal identifications of your plug, connect as follows:

Blue wire to terminal coded N (Neutral) or coloured Black.
Brown wire to terminal coded L (Live) or coloured Red.

If in doubt – consult a competent electrician.

2 Safety Precautions about PC-XT3

IMPORTANT FOR LASER PRODUCTS

PRECAUTIONS

1. CLASS 1 LASER PRODUCT
2. **DANGER:** Invisible laser radiation when open and interlock failed or defeated. Avoid direct exposure to beam.
3. **CAUTION:** Do not open the rear cover. There are no user serviceable parts inside the unit; leave all servicing to qualified service personnel.
4. **CAUTION:** The compact disc player uses invisible laser radiation and is equipped with safety switches which prevent emission of radiation when the disc holder is open and the safety interlocks have failed or are defeated. It is dangerous to defeat the safety switches.
5. **CAUTION:** Use of controls of adjustments or performance of procedures other than those specified herein may result in hazardous radiation exposure.
6. **CAUTION:** The laser is able to function, if safety switches are out of function. The laser light is invisible, avoid exposure, do not disassemble the laser unit, but replace the complete unit.



Free service manuals
Gratis schema's

Digitized by

www.freeservicemanuals.info

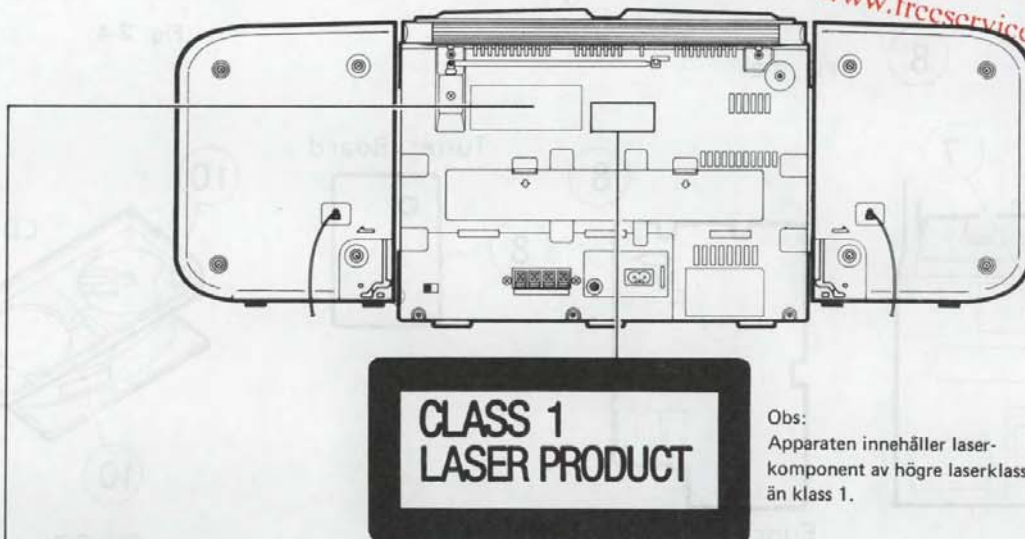

Obs:
Apparaten innehåller laserkomponent av högre laserklass än klass 1.



The lightning flash with arrowhead symbol, within an equilateral triangle, is intended to alert the user to the presence of uninsulated "dangerous voltage" within the product's enclosure that may be of sufficient magnitude to constitute a risk of electric shock to persons.



The exclamation point within an equilateral triangle is intended to alert the user to the presence of important operating and maintenance (servicing) instructions in the literature accompanying the appliance.

ADVARSEL-Der vil udstråles osynlig laserbestråling når apparatet åbnes og aflåsningsmekanismen frigøres. UNDGÅ AT BLIVE UDSET FOR LASERBESTRÅLING.

DANGER-Invisible laser radiation when open and interlock defeated. AVOID DIRECT EXPOSURE TO BEAM.

VND4220-001

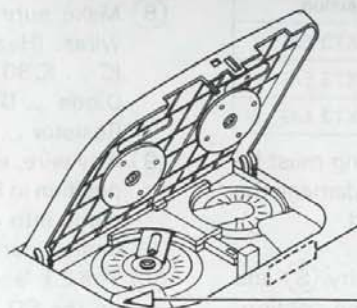

VAROITUS! Laite sisältää laserdiodin, joka lähettää näkymätöntä silmille vaarallista lasersäteilyä.

Fig. 2-1

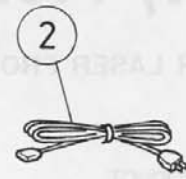
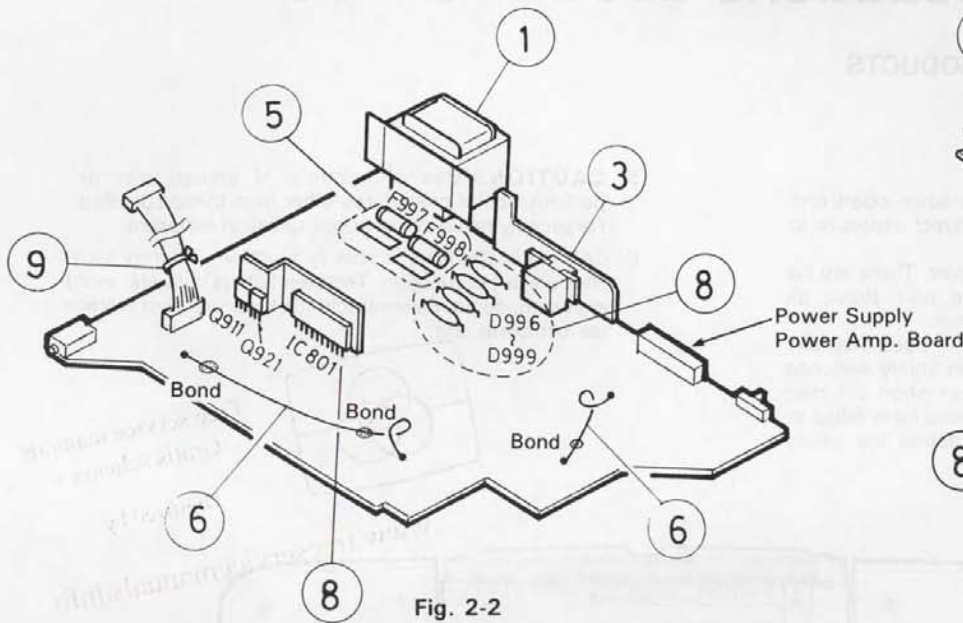

Fig. 2-3

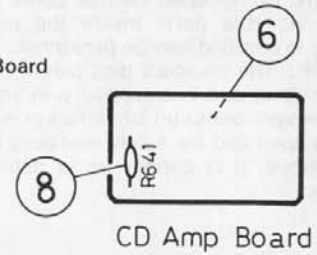
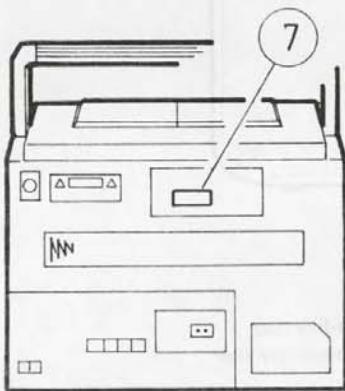
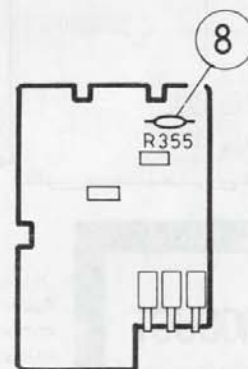

Fig. 2-4



Rear View

Fig. 2-5



Function Board

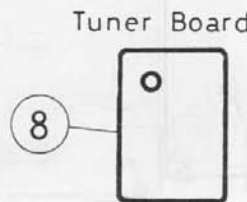

Fig. 2-6

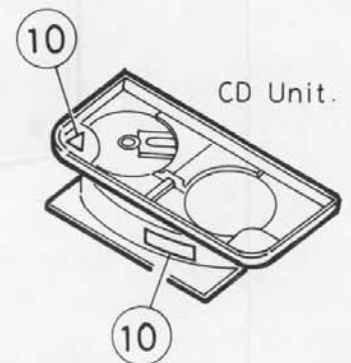

Fig. 2-7

Important Management Points Regarding Safety (Items Demanding Special Safety Precautions)

• Numerals in the circle indicate relating parts in the above figure.

- ① When replacing the power transformer, confirm the marking PC-XT3 B/E/G approval number: "VTP57P2-12F" on the power transformer and re-install it with full torque of the screwdriver. The primary terminal and the adjacent secondary terminal on the P.C. board; provide proper creeping and spatial distance and control that solder does not protrude from soldering round.
- ② Confirm the next marking on the power cord and check the appearance about damage.

	Marking	Version
Cord	▷ VDE ◁	PC-XT3 E/G
Attachment plug	" (S) "	PC-XT3 E/G
Connector plug	KS-15F for KS-15	PC-XT3 E/G

- ③ Concerning the AC socket the next marking must be confirmed and to avoid P.C. board pattern damage the AC socket must not float from P.C. Board.
Marking: HSC1466 ... PC-XT3 B/E/G
- ⑤ Before installation, Confirm the fuse capacity (S) and ♡, marks on the fuse cap when installing confirm,

if the fuse is held tightly with the fuse holder and the capacity indication the P.C. Board.

Version	Ref. No.	Capacitor & Mark	Indication on the board
E/G	F997	T3.15A	T3.15A
E/G	F998	T3.15A	T3.15A

- ⑥ The parts and wire on the pattern side of the P.C. board must be fixed with spacers or bond.
- ⑦ The class 1 label must be attached PC-XT3 B/E/G.
- ⑧ Make sure that each of the electric condenser and wires. (Heating parts)
IC ... IC801, Transistor ... Q911, Q921
Diode ... D996~D999
Resistor ... R355, R641
- ⑨ Any wire, etc. should be clamped or fixed firmly at the position in Fig. 2-2 so that such wire, etc. would never come into contract with any live part, movable part, heated part and sharp edge portion.
- ⑩ The E.I. laser mark and laser caution must be attached on the CD part. (PC-XT3 B/E/G)

3 Features

- Portable system incorporating a multi-function Twin-CD player.**
 - Twin-CD player with programmable play of up to 20 tunes/repeat play/random play/intro play functions.
 - 8-cm (3-3/16") "CD singles" capability.
- Synchro-record start for CD recording convenience.**
- Double-cassette mechanism (Deck A for recording and playback, Deck B for playback).**
 - Metal and CrO₂ tape can be played back, for superior tone quality.
 - Synchro start dubbing function (normal/high-speed dubbing).
 - Relay playback (from Deck B to Deck A).
 - Full auto-stop mechanism.
- SUPER BASS HORN system.**



Free service manuals
Gratis schema's
Digitized by

www.freeservicemanuals.info

4 Specifications

Compact disc player section

Type	: Compact disc player
Signal detection system	: Non-contact optical pickup (semiconductor laser)
Number of channels	: 2 channels (stereo)
Frequency response	: 20 Hz – 20,000 Hz
Signal-to-noise ratio	: 76 dB
Wow & flutter	: Less than measurable limit

Radio section

Frequency ranges	: FM 88 – 108 MHz SW 6 – 18 MHz MW 540 – 1,600 kHz LW 150 – 280 kHz
Antennas	: Telescopic antenna for FM & SW Ferrite core antenna for MW & LW

Tape deck section

Track system	: 4-track 2-channel stereo
Motor	: Electronic governor DC motor for capstan
Heads	: Deck A; Hard permalloy head (for recording/playback), Permalloy head for erasure Deck B; Hard permalloy head for playback
Frequency response	: 63 – 12,500 Hz (with normal tape/normal speed)
Wow & flutter	: 0.15 % (WRMS)
Fast wind time	: Approx. 120 sec. (C-60 cassette)

General

Power output	: 16W (8 W + 8 W) at 3 Ω (Max.) 10W (5W+5W) at 3Ω (10 % THD)
Output terminals	: Speaker x 2 (matching impedance 3-8 Ω) PHONES x 1 (Output level: 0–15 mW/32 Ω) Matching impedance: 16 Ω-1k Ω

Power supply	: AC 240 V, 50/60 Hz (PC-XT3B) AC 230V, 50/60 Hz (PC-XT3E/G) DC 12 V (8 "R20" batteries) Ext. DC IN 12V (car battery via car adaptor available from an audio store)
Power consumption	: 32 W (with POWER SW ON) 2.1 W (with POWER SW STANDBY)
Dimensions	: 692(W) × 271(H) × 261(D) mm (27-1/4" × 10-11/16" × 10 5/16") including knobs
Weight	: Approx. 7.8kg (17.2 lbs) (without batteries) Approx. 8.6 kg (19 lbs) (with batteries)
Speaker Section (each unit)	
Speakers	: 10 cm (3-15/16") × 1
Impedance	: 3 Ω
Dimensions	: 175(W) × 239(H) × 208(D) mm (6-15/16" × 9-7/16" × 8-1/4")
Weight	: Approx. 1.3 kg (2.9 lbs)

Design and specifications are subject to change without notice.

5 Instructions (Extract)

NAME OF PARTS AND THEIR FUNCTIONS

• Top panel

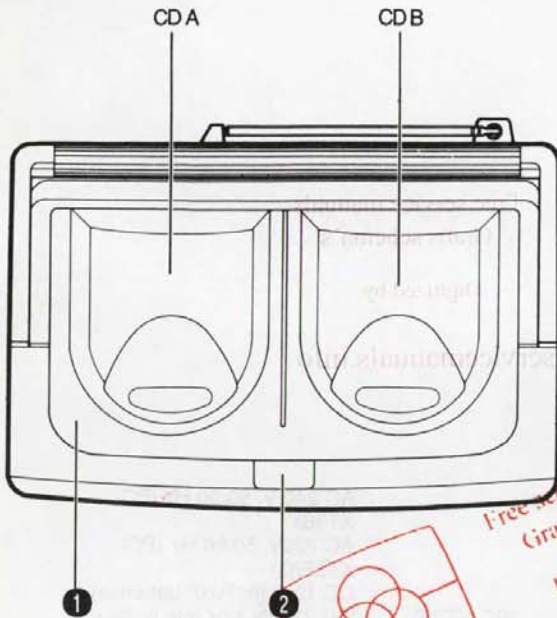

- 1 Disc holder
- 2 Disc holder open button (PUSH OPEN) (▲)

3

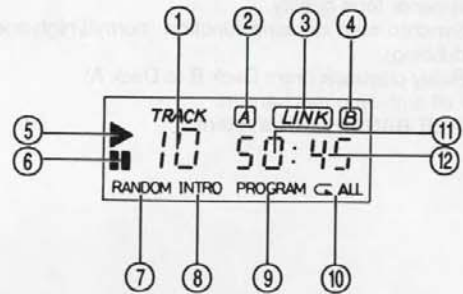

3 Display window (CD player section)

- 1 Track (tune) number display
- 2 CD A indicator
- 3 LINK indicator
- 4 CD B indicator
- 5 Play indicator (▶)
- 6 Pause indicator (||)
- 7 RANDOM playback indicator
- 8 INTRO scan indicator
- 9 Program mode indicator (PROGRAM)
- 10 Repeat playback indicator (◁ ALL)
- 11 Program order number/Time (minute) display
- 12 Time (second) display

• Front panel

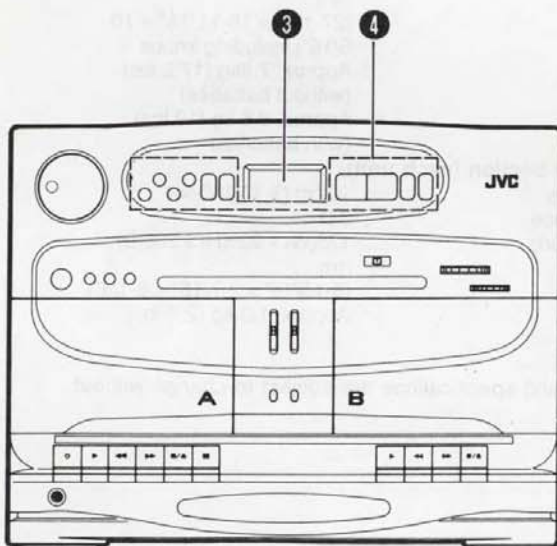

4

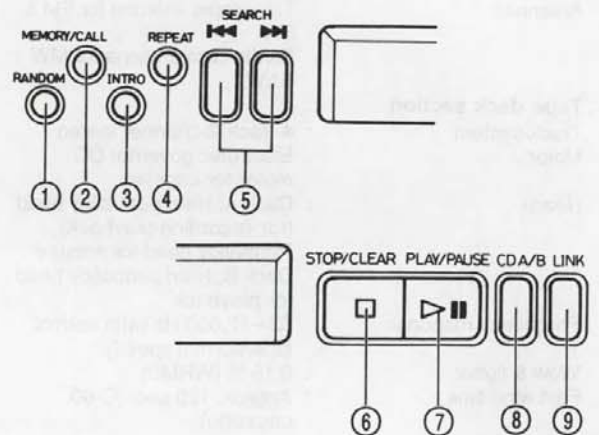

4 CD operation buttons

- 1 RANDOM button
- 2 MEMORY/CALL button
- 3 INTRO button
- 4 REPEAT button
- 5 SEARCH (◀▶) button
- 6 STOP/CLEAR (□) button
- 7 PLAY/PAUSE (▶||) button
- 8 CD A/B select button
- 9 LINK button

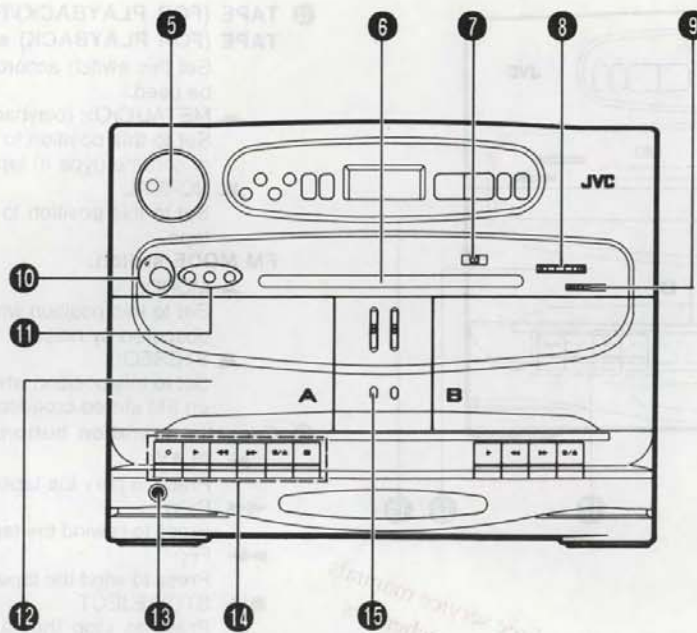
**5 VOLUME control****6 Dial scale****7 BAND switch (FM/SW/MW/LW)****8 TUNING knob****9 FINE TUNING knob****10 POWER switch and indicator (See page 4.)****11 FUNCTION switch****CD**

Set to this position when listening to or recording from a CD.

TAPE

Set to this position to listen to a cassette or perform dubbing a tape.

TUNER

Set to this position when listening to or recording from the radio.

12 Cassette holder (Deck A)**13 PHONES jack (3.5 mm dia. stereo mini)**

Connect headphones (impedance $16 \Omega - 1 \text{ k}\Omega$) to this jack. The speakers are automatically switched off with the headphones connected.

14 Cassette operation buttons (Deck A)**○ REC:**

Press this button with the ► PLAY button to start recording.

► PLAY:

Press to play the tape.

◀◀ REW:

Press to rewind the tape rapidly.

▶▶ FF:

Press to wind the tape forward rapidly.

■/▲ STOP/EJECT:

Press to stop the tape. Pressing this button after the tape stops opens the cassette holder.

■ PAUSE:

Press to stop the tape temporarily. Press again to release the pause mode.

15 DUBBING SPEED switch**— HIGH:**

Set to this position when dubbing at high-speed.

■ NORMAL:

Set to this position when dubbing at normal-speed.

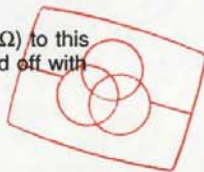

Free service manuals
Gratis schema's
Digitized by
www.freecservicemanuals.info

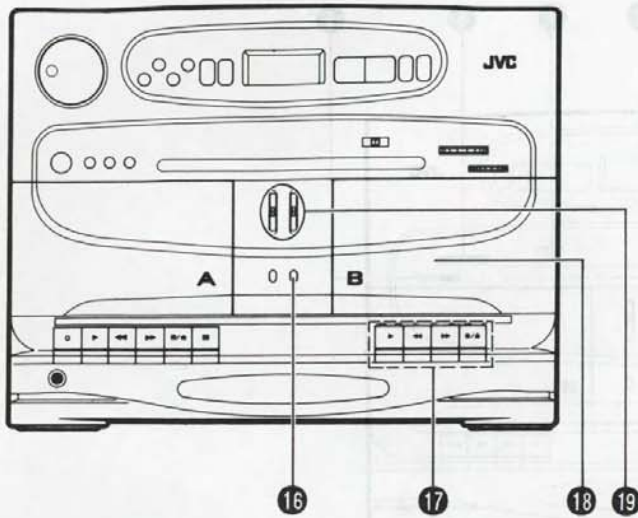

16 TAPE (FOR PLAYBACK)/FM MODE switch

TAPE (FOR PLAYBACK) switch:

Set this switch according to the type of tape to be used.

■ METAL+CrO₂: (playback only)

Set to this position to listen to a metal (type IV) or chrome (type II) tape.

■ NORMAL

Set to this position to listen to a normal (type I) tape.

FM MODE switch:

■ MONO:

Set to this position when FM stereo reception is obscured by noise.

■ STEREO:

Set to this position when listening to or recording an FM stereo broadcast.

17 Cassette operation buttons (Deck B)

▶ PLAY:

Press to play the tape.

◀◀ REW:

Press to rewind the tape forward rapidly.

▶▶ FF:

Press to wind the tape forward rapidly.

■/▲ STOP/EJECT:

Press to stop the tape. Pressing this button after the tape stops opens the cassette holder.

18 Cassette holder (Deck B)

19 BASS-TREBLE controls

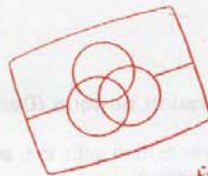

Free service manuals
Gratis schemas
Digitized by

www.freeservicemanuals.info

• Rear panel

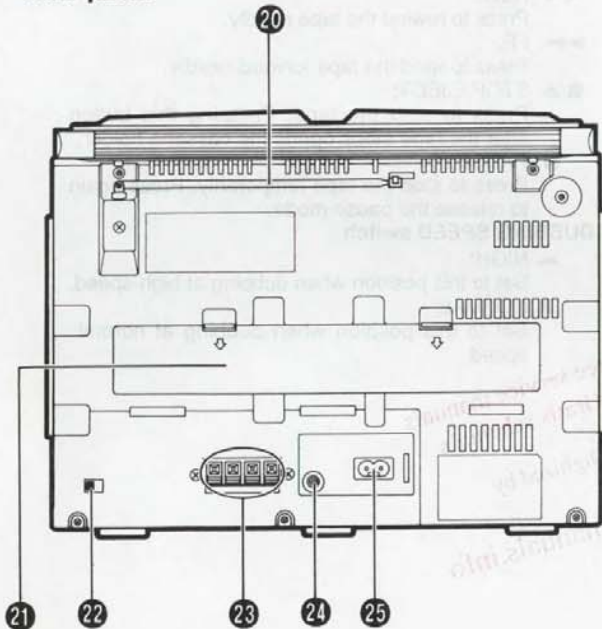

20 Telescopic antenna

21 Battery compartment cover

22 BEAT CUT switch (See page 34)

23 SPEAKER terminals

Connect the provided speakers to these terminals

24 DC IN 12 V jack (⊖ ⊕) (PC-XT3E)

25 AC IN (AC input) jack

PLAYING COMPACT DISCS

Entire tune playback
 (The example shows CD A.)
Operate in order shown

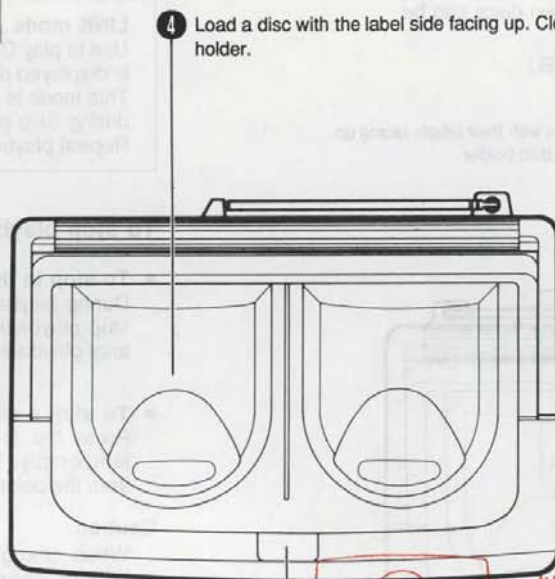

4 Load a disc with the label side facing up. Close the disc holder.

3 Press to open the disc holder.

Free service manuals
 Gratis schema's

Digitized by

www.freeservicemanuals.info

6 Press to start the playback. The track (tune) number and playback time are displayed.

5 Set to CD A.

7 Adjust.

1 Set to ON.

2 Set to CD

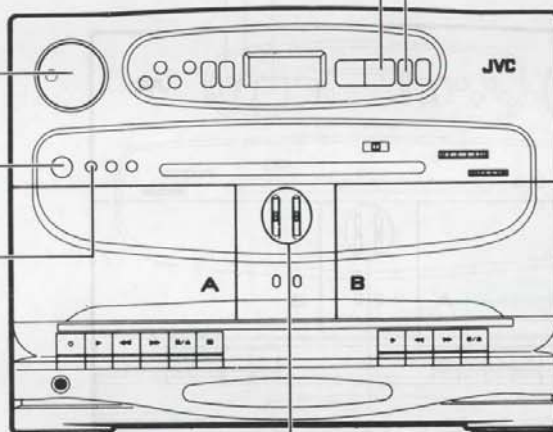

8 Adjust.

- To play CD B, load a disc into CD B and press the CD A/B select button to set to the CD B play mode and repeat steps **6** - **8** above.

To play both CD A and CD B ... Two discs can be played one after the other.
(The example shown CD A first, then CD B.)

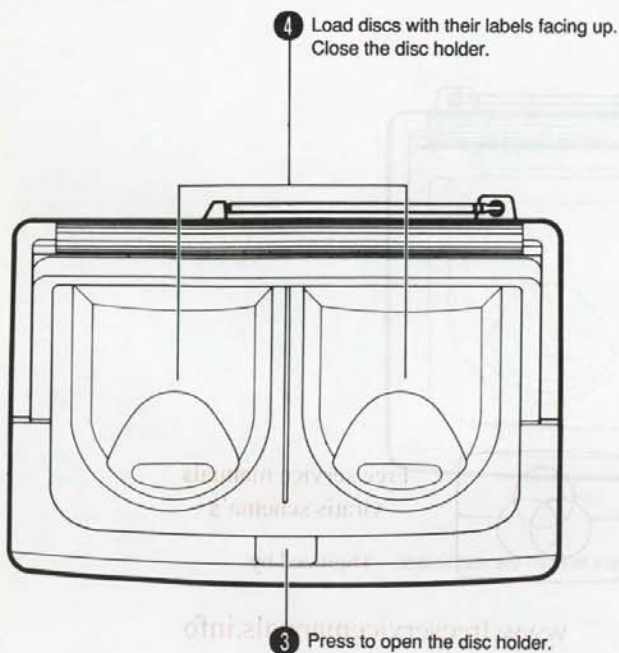

7 Press to start the playback. The track (tune) number and playback time are displayed.

LINK mode

Use to play CD A and CD B, one after the other. **LINK** is displayed during this mode.
This mode is also activated to use both CDs A and B during Skip play, Programmed playback, Intro-scan, Repeat playback, Random playback.

To stop playback

- **To stop in the middle of a disc**
During playback, press the STOP/CLEAR button to stop playback. The total number of tracks (tunes) and total playback time are displayed.
- **To stop a disc temporarily**
Press the PLAY/PAUSE button to stop a disc temporarily. When pressed again, playback resumes from the point where pause was engaged.

Caution:

When changing discs, press the STOP/CLEAR button; check that the disc has stopped rotating completely before unloading it.

Notes:

- The following indication may be shown when a disc is dirty or scratched, or when the disc is loaded upside down.
In such a case, check the disc and insert it again and clean or change the disc.



5 Set to CD A.

6 Set to LINK mode on.

8 Adjust.

1 Set to ON.

2 Set to CD

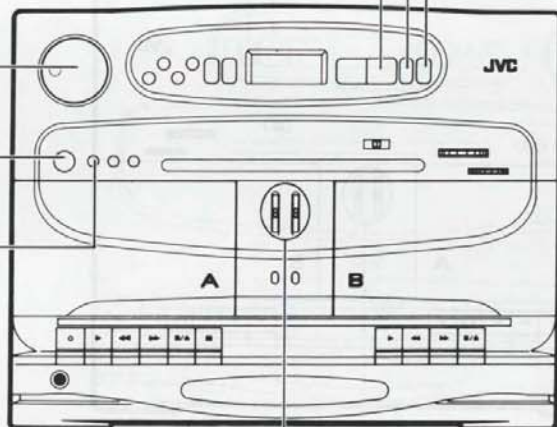

9 Adjust.

- When playing CD B first, set to the CD B play mode using the CD A/B select button and repeat steps 6 - 9 above.

Notes:

1. To switch to the other during CD operation, press the STOP/CLEAR button and then select the other disc using the CD A/B select button.
2. After the two CDs have been played, the Twin-CD player stops automatically.

- Do not use the unit at excessively high or cold temperatures.

The recommended temperature range is 5°C (41°F) to 35°C (95°F).

- After playback, unload the disc and close the disc holder.
- If mistracking occurs during playback, lower the volume.
- Mistracking may occur if the unit is given a strong impact or is used in a place which is subject to vibrations (i.e. in a car travelling on a rough road).

Skip playback

- During playback, when skipping to the beginning of the next tune or the tune being played back or the previous tune, the beginning of the tune is easily located and the playback starts from there.

To listen to the next tune...

Press the **▶▶** button once to skip to the beginning of the next tune.



To listen to the previous tune . . .

Press the **◀◀** button to skip to the beginning of the tune being played back and press again to skip to the previous tune.



Search playback (to locate the required position on the disc)

- The required position can be located using fast-forward or reverse search during playback.



- Hold down the button and the search playback starts slowly and then gradually increases speed.
- Since a small sound (about one quarter of playback level) can be audible in both modes, release the button when the required position is located while monitoring the sound.

Programmed playback

- Up to 20 tunes can be programmed.
(Programmed playback of CD A or CD B only)

①



②



③

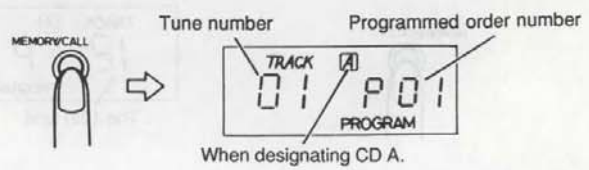

④

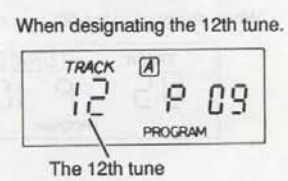

⑤

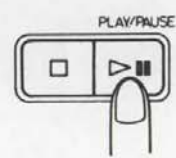

- ① Select CD A or CD B with the CD A/B select button.
- ② Press to designate the required track number.
- ③ Press the MEMORY/CALL button to program the track (tune) number.
- ④ Repeat steps ② and ③ to program other tunes.
- ⑤ Press the **▶||** PLAY/PAUSE button when programming is completed. Programmed playback starts.

- Up to 20 tunes can be programmed.
(Programmed playback of CDs A and B)

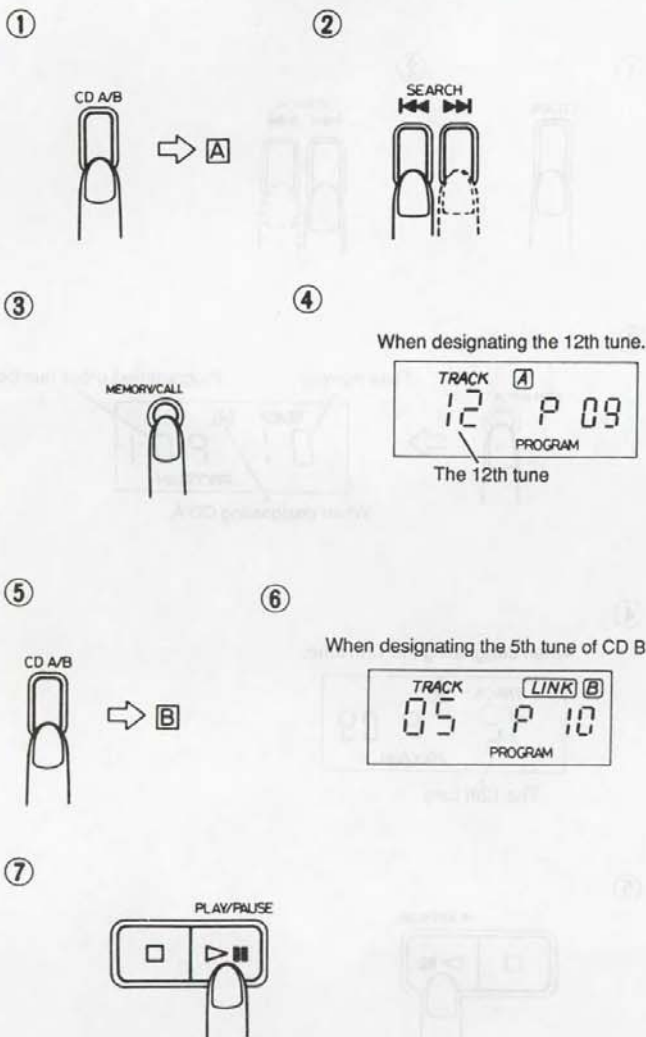

When designating the 12th tune.

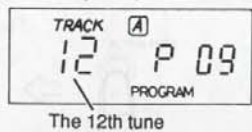

When designating the 5th tune of CD B.

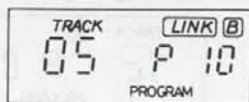

- ① Set to the CD A play mode using the CD A/B select button.
- ② Press to designate the required track number.
- ③ Press the MEMORY/CALL button to program the track (tune) number.
- ④ Repeat steps ② and ③ to program other tunes.
- ⑤ Set to the CD B play mode using the CD A/B select button.
- ⑥ Repeat steps ② and ③ to program other tunes.
- ⑦ Press the ▷|| PLAY/PAUSE button when programming is completed. Programmed playback starts.
 - When programming tunes from both CD A and CD B, use the CD A/B select button to switch between the two CD.

To clear programmed tunes ...

Press the □ STOP/CLEAR button before playback. During programmed playback, press this button twice. When the disc holder is opened, the programmed tunes are automatically cleared.

To confirm the details of programmed tunes...

When the MEMORY/CALL button is pressed, the details of programmed tunes are displayed in the programmed order.



Tune number Program order number

INTRO-scan operation

- Just press to play the first 15 seconds of each tune. The operation is released after playing the introductory sections of all tunes or all programmed tunes.
- If the INTRO-scan button is pressed in the middle of a tune, the intro scan operation will start from the next tune.
- To release the intro scan mode, press the INTRO-scan button again and normal playback (or programmed playback) will start.

Repeat playback

Press the REPEAT button before or during playback. A single tune or all the tunes can be repeated.

A single tune and all the tunes can be specified separately. Each time the REPEAT button is pressed, the mode will be changed from a single tune (↺) to all the tunes (↺ ALL) to the clear mode, in this order.

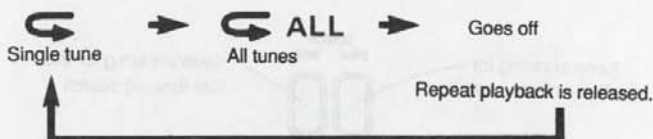

- Repeat playback of a single tune (↺)
The tune being played back can be heard repeatedly.
- Repeat playback of all the tunes (↺ ALL)
When playing back the entire disc or programmed tunes, all the tunes or the programmed tunes can be heard repeatedly.

Random playback

When the RANDOM button is pressed, every tune in a disc is played back once, in random order.

CASSETTE PLAYBACK

(The example shows deck A)
Operate in order shown.

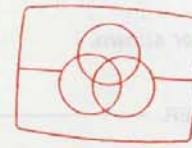
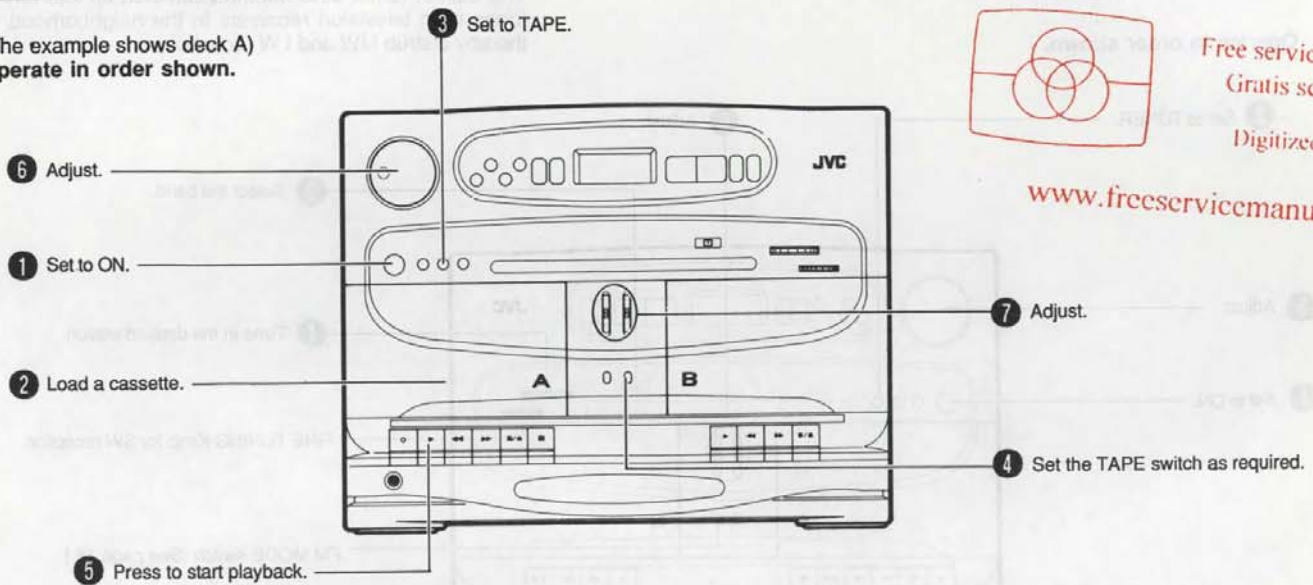

Free service manuals
Gratis schema's

Digitized by

www.freecservicemanuals.info

• Playback in deck B

The previous procedures 1 and 5 also apply to deck B when a cassette is loaded in deck B. When decks A and B are simultaneously set to the play mode, only the playback sound of deck B is heard.

Notes:

1. When the power is turned off while the tape is running, cassette operation buttons which are depressed do not return to the original positions. Press the ■/▲ STOP/EJECT button to stop the tape running before turning off the power.
2. Avoid operating the FF or REW button on the deck during playback of the other deck.

RELAY PLAYBACK

(From deck B to deck A)
Operate in order shown.

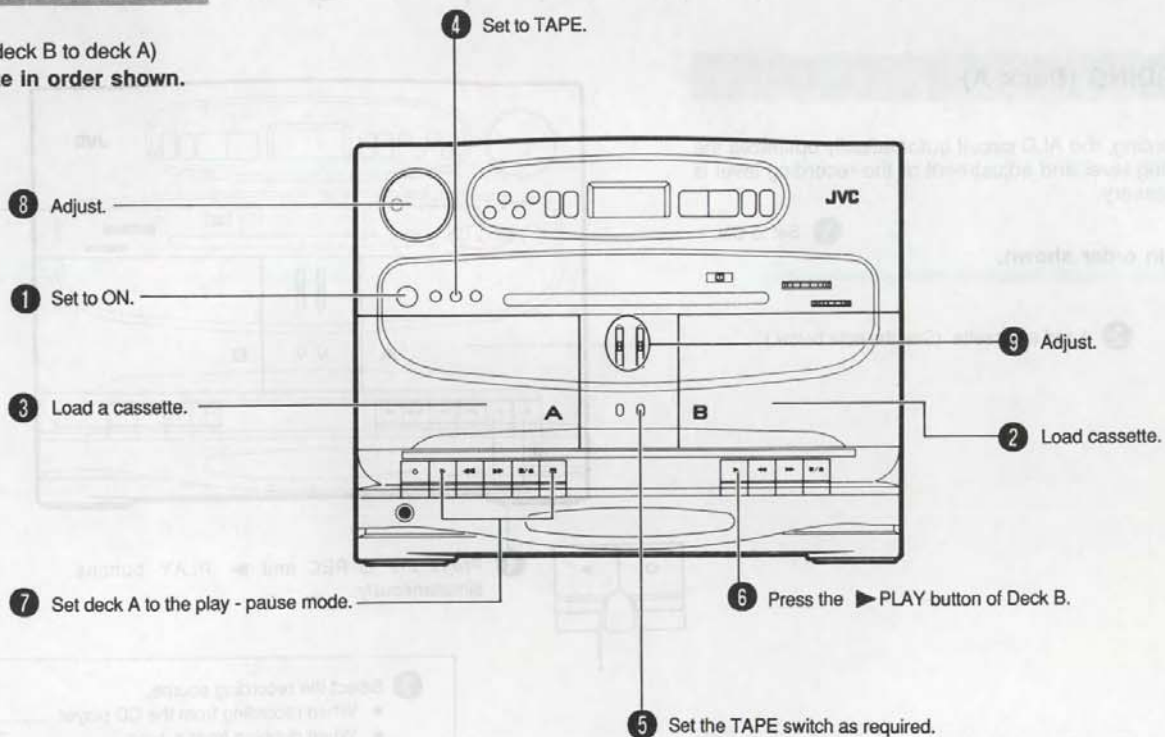

Notes:

1. Use the same type of tape in decks A and B.
2. When deck B stops, deck A's pause mode will be released and it will start playback. When deck A stops automatically, relay playback will be released.

RADIO RECEPTION

Operate in order shown.

Note:

The built-in ferrite core antenna can pick up interference tones from television receivers in the neighborhood and thereby disturb MW and LW reception.

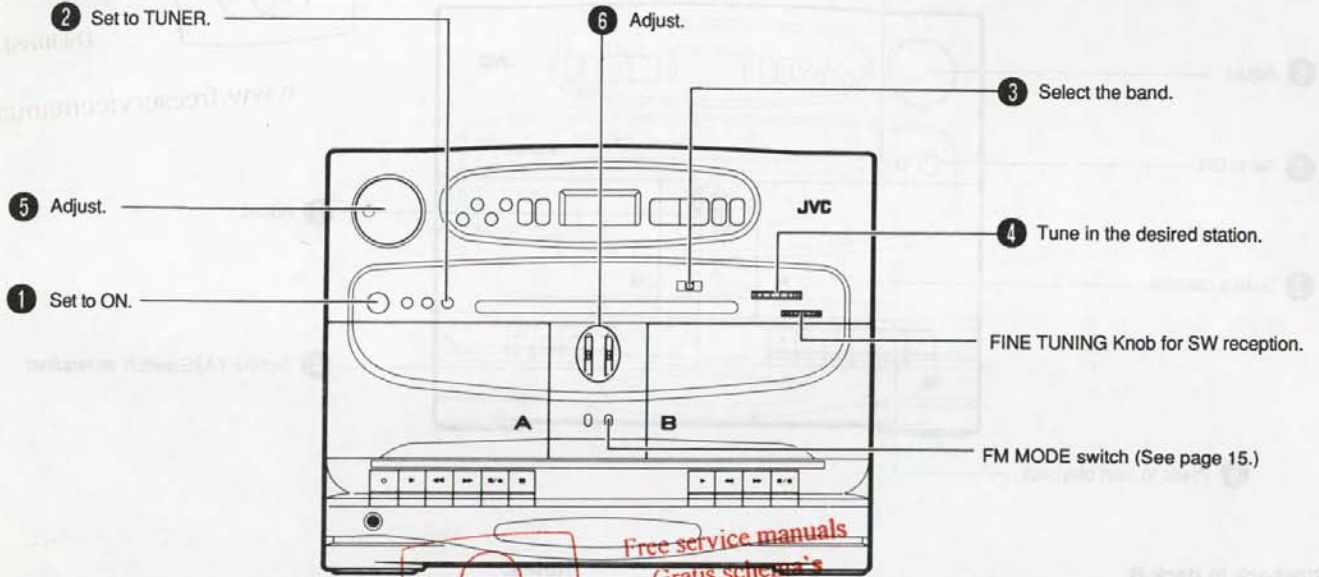

Using the antennas

FM

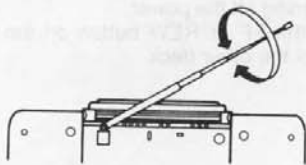

SW
Digitized by
www.freesevicemanuals.info

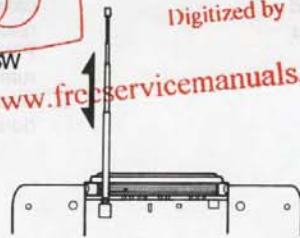

MW and LW

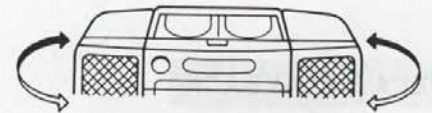

RECORDING (Deck A)

- In recording, the ALC circuit automatically optimizes the recording level and adjustment of the recording level is unnecessary.

Operate in order shown.

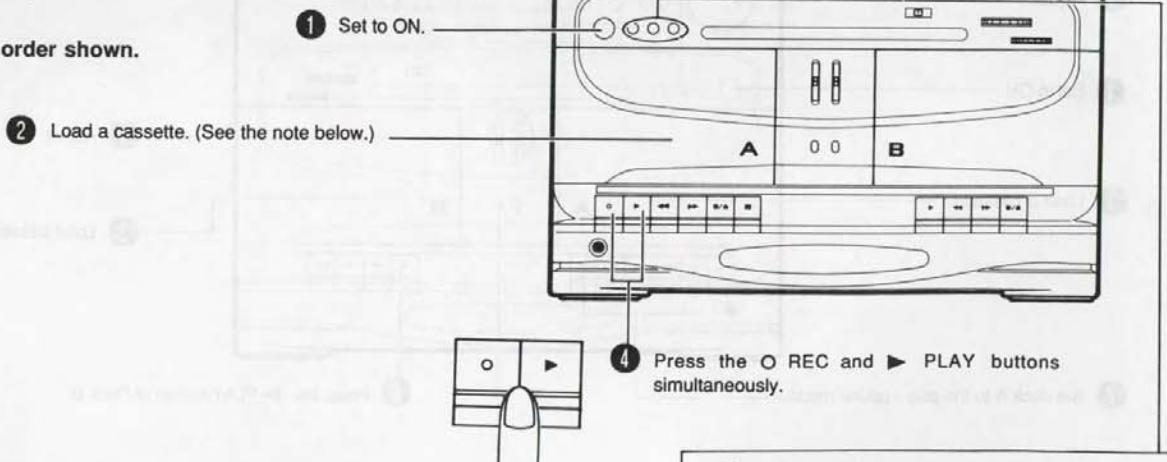

Notes:

1. The recording characteristics of this unit are those of normal tape. Normal tape has different characteristics from CrO₂ and metal tapes.
2. Avoid operating the FF or REW button on deck B during recording.

3. Select the recording source.
 - When recording from the CD player CD
 - When dubbing from a tape.....TAPE
 - When recording from the radio.....TUNER



Synchronized recording with the CD Player

- In this system, the CD player starts playback when deck A enters the recording mode.

Operate in order shown.

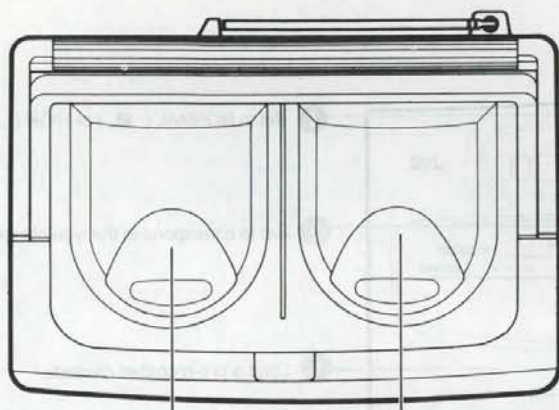

2 Load a disc.

- Non-recorded sections of approx. 4 seconds are left automatically between tunes.
- When the tape reaches the end first, the CD player stops automatically; when the CD player stops first, the tape continues running. In this case, press the ■/▲ STOP/EJECT button to stop the tape.

• When automatic spacing between tunes is not required ...

Perform the following after finishing the previous operation (1-4).

- 1 Press the ▷|| PLAY/PAUSE button of the CD player twice. The CD player enters the pause mode.
- 2 Press the ○ REC and ► PLAY buttons simultaneously. Now, the CD player starts playback simultaneously.



Free service manuals

Gratis schema's

Digitized by

www.freeservicemanuals.info

- 4 • Program tunes when programmed playback is required.
 - When two CDs are to be recorded one after the other, select whether CD A or CD B is to be recorded first and set to the LINK mode.

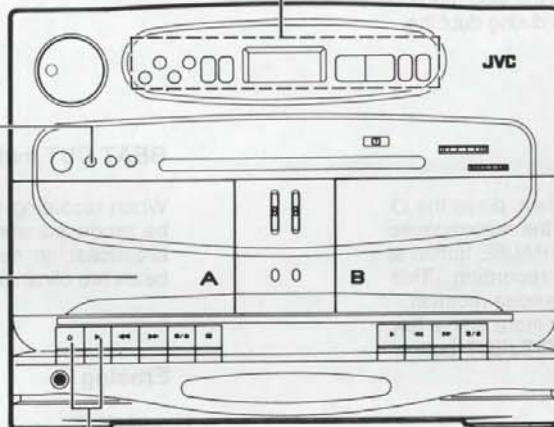

3 Set to CD.

1 Load a cassette.

- 5 Press the ○ REC and ► PLAY buttons simultaneously. Now, the CD player starts playback simultaneously.

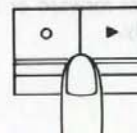

DUBBING (SYNCHRO START DUBBING)

Normal and high-speed dubbing can be done from deck B to deck A.

Operate in order shown.

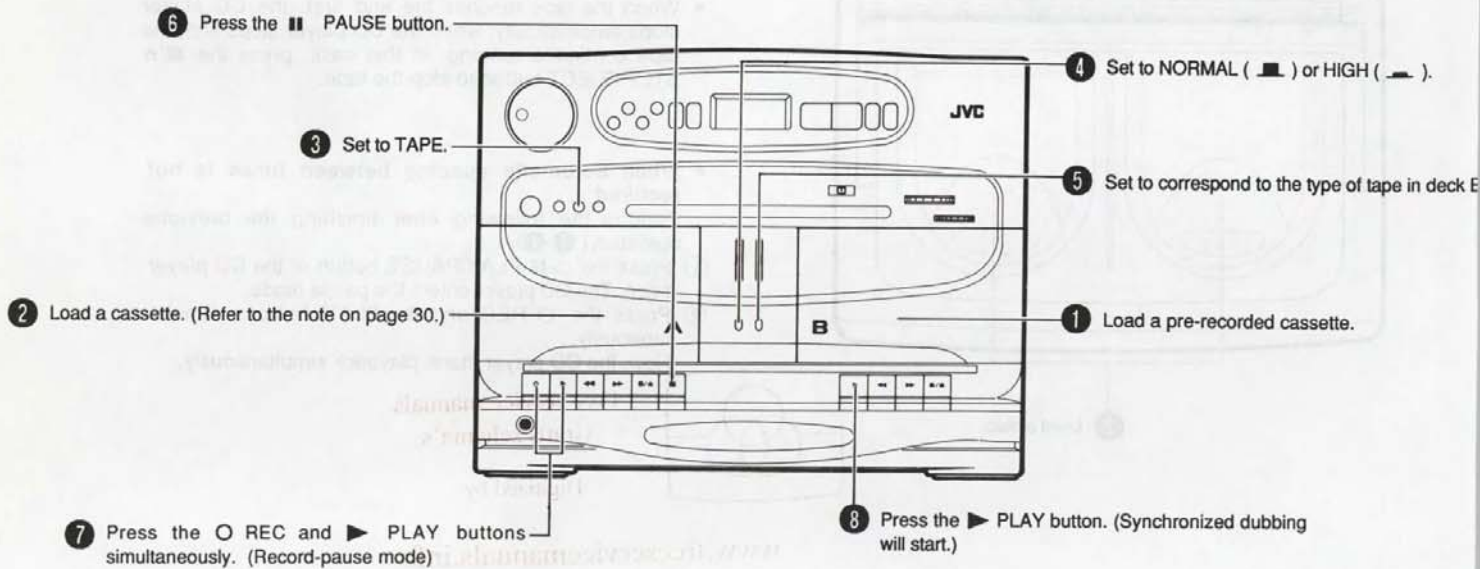

Notes:

- Television receivers placed close to this unit may cause interference on the recorded signal when this unit is used in the high-speed dubbing mode. If this happens, either turn off the television receiver or use the normal-speed dubbing mode.
- With deck A in the record-pause mode, the **||** PAUSE button is released when deck B enters the stop mode.
- Avoid switching the FUNCTION switch during dubbing.

|| PAUSE button

First of all, press the **||** PAUSE button. Then, press the **○** REC and **▶** PLAY buttons, thus entering the record-pause (standby) mode. After that re-press the **||** PAUSE button at the exact moment you want to start recording. This releases the tape to begin recording at a precise moment.

- Do not leave the unit in pause mode for more than a few minutes. Instead, push the **■/▲** STOP/EJECT button and turn the power off.

Full auto-stop mechanism (both decks A and B)

When the tape reaches either end during the recording/playback and fast forward or rewinding mode, the tape stops automatically.

BEAT CUT switch

When recording an MW, LW or SW broadcast, beats may be produced which are not heard when listening to the broadcast. In such a case, set this switch so that the beats are eliminated. Normally set this switch to "NORM 1".

Erasing

When recording on a prerecorded tape, the previous recording is automatically erased and only the new program is recorded on the tape.

To erase a tape without making a new recording...

Follow the section "RECORDING" but in step ③, set the FUNCTION switch to TAPE then perform recording to erase the tape.

6 Location of Main Parts

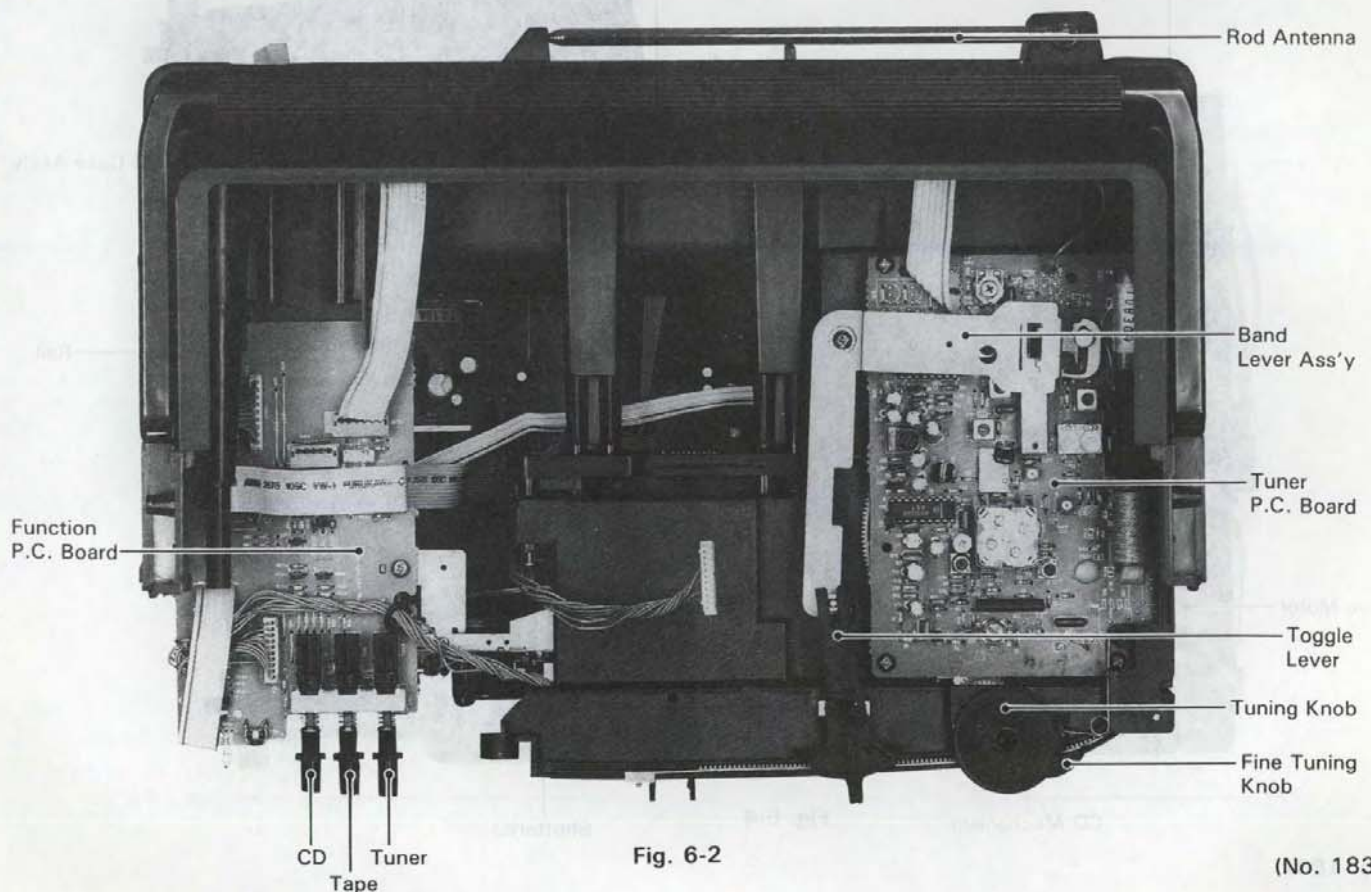
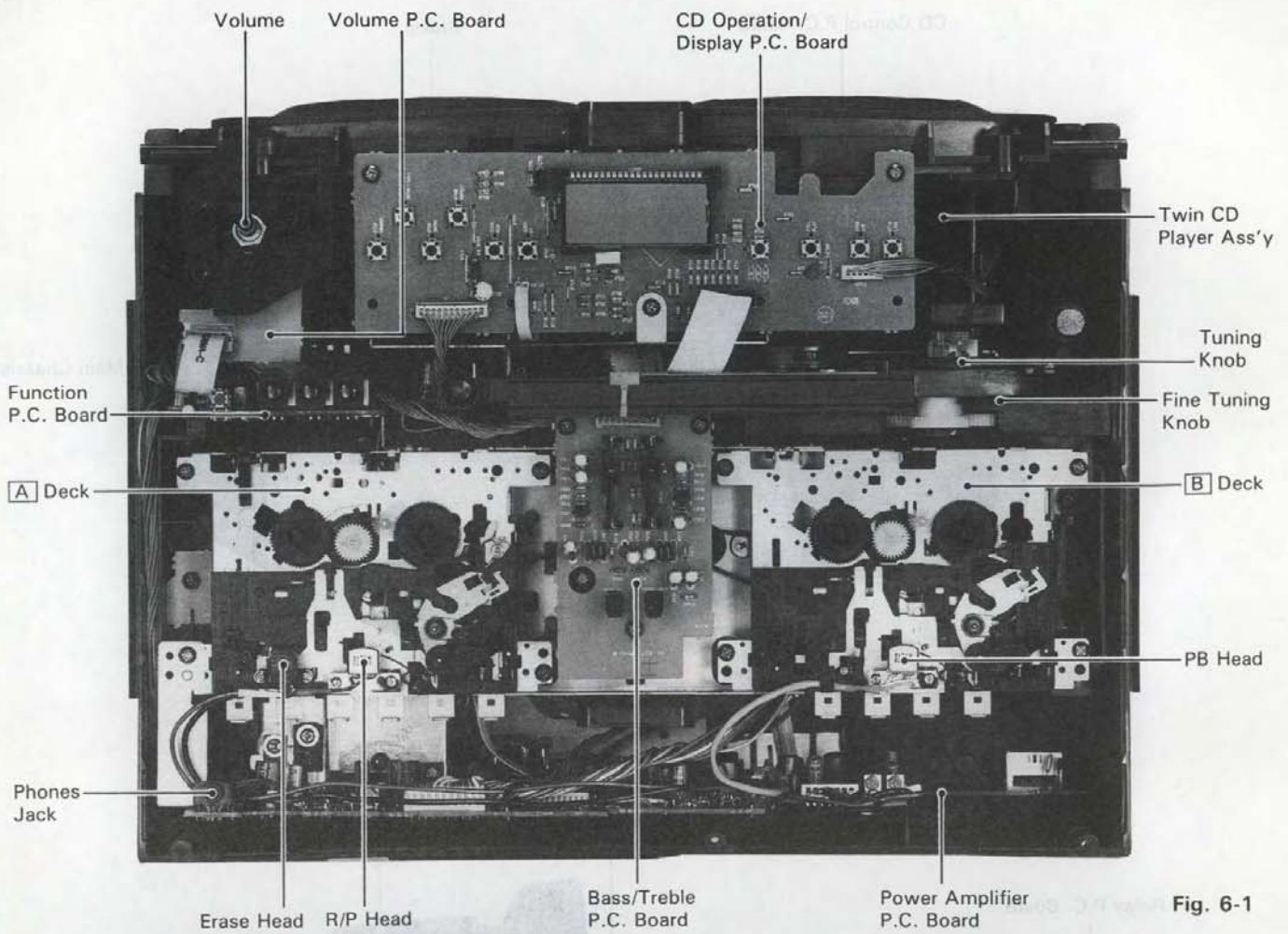

(Twin CD Player Ass'y)

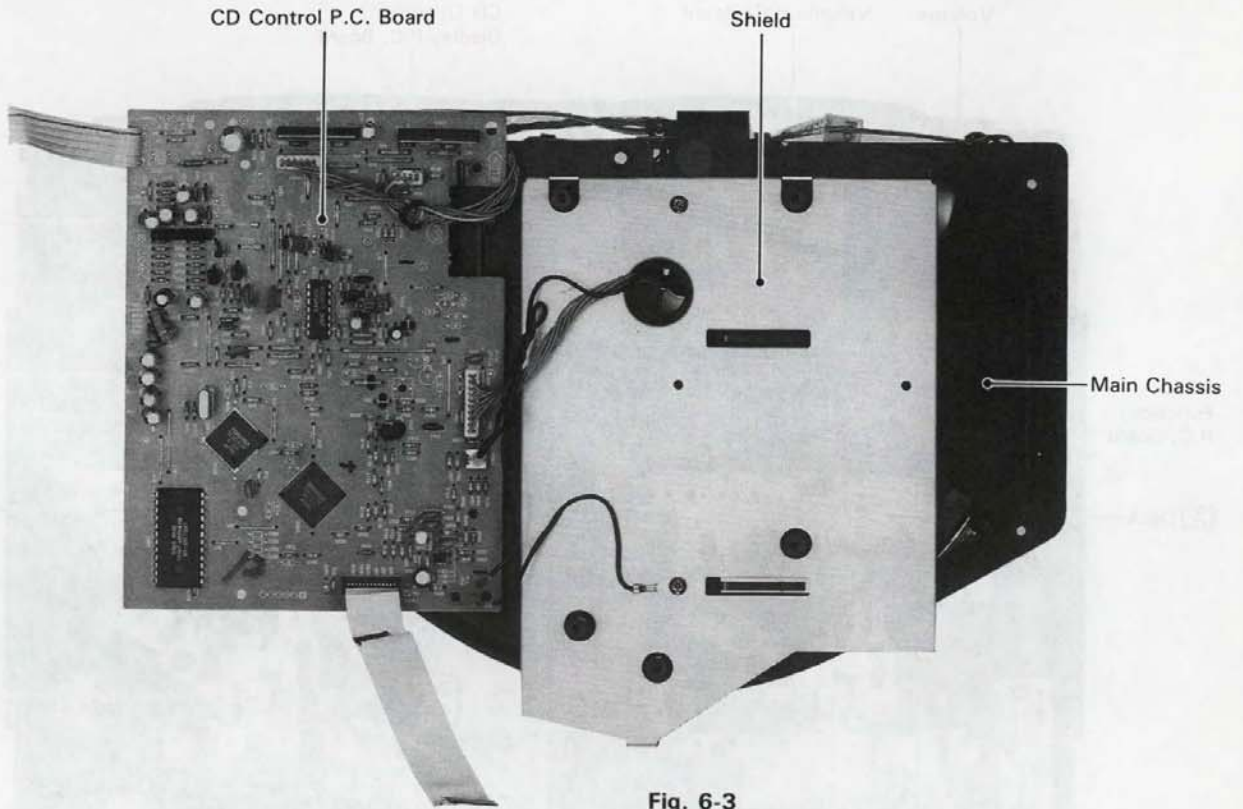

Fig. 6-3

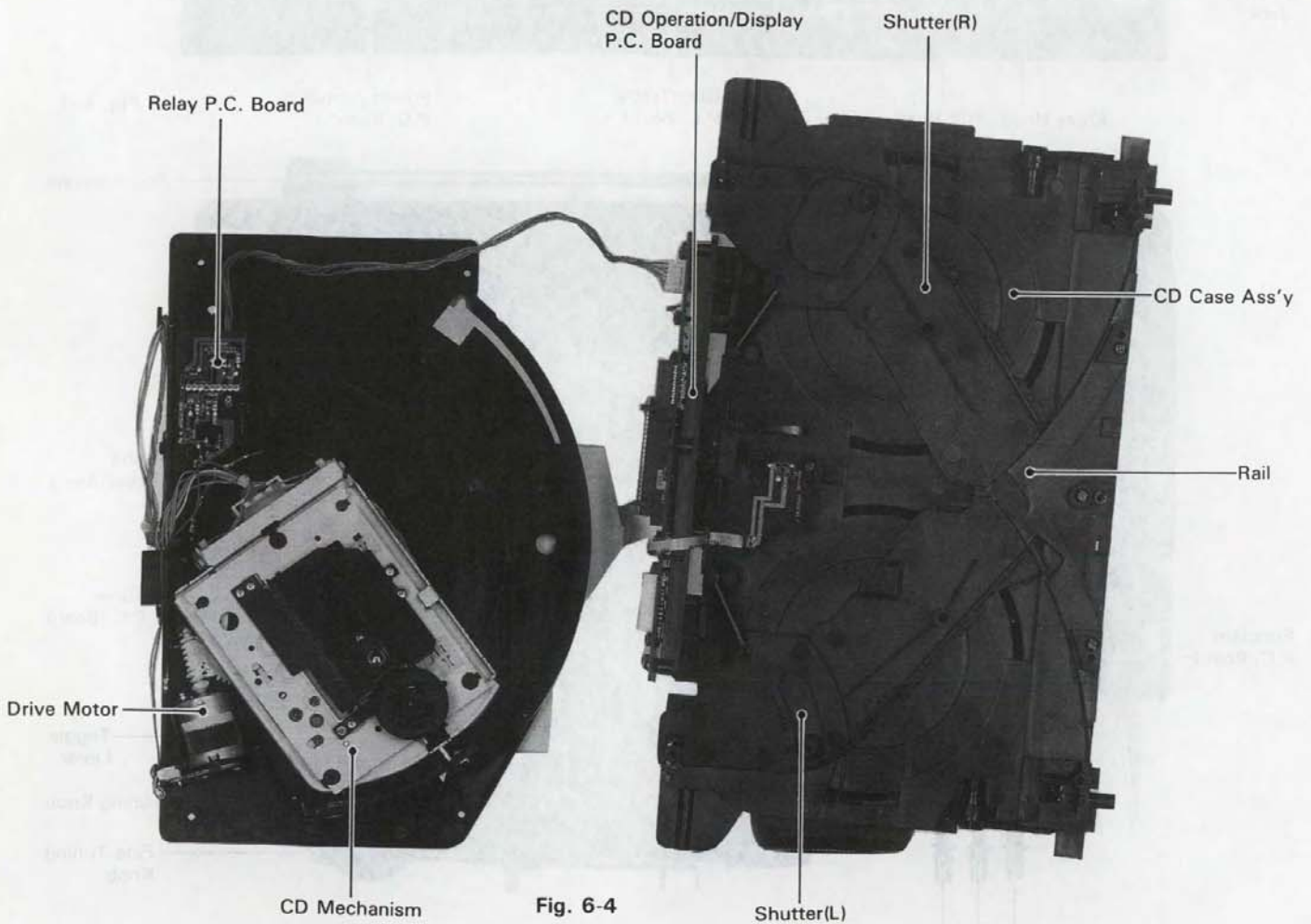
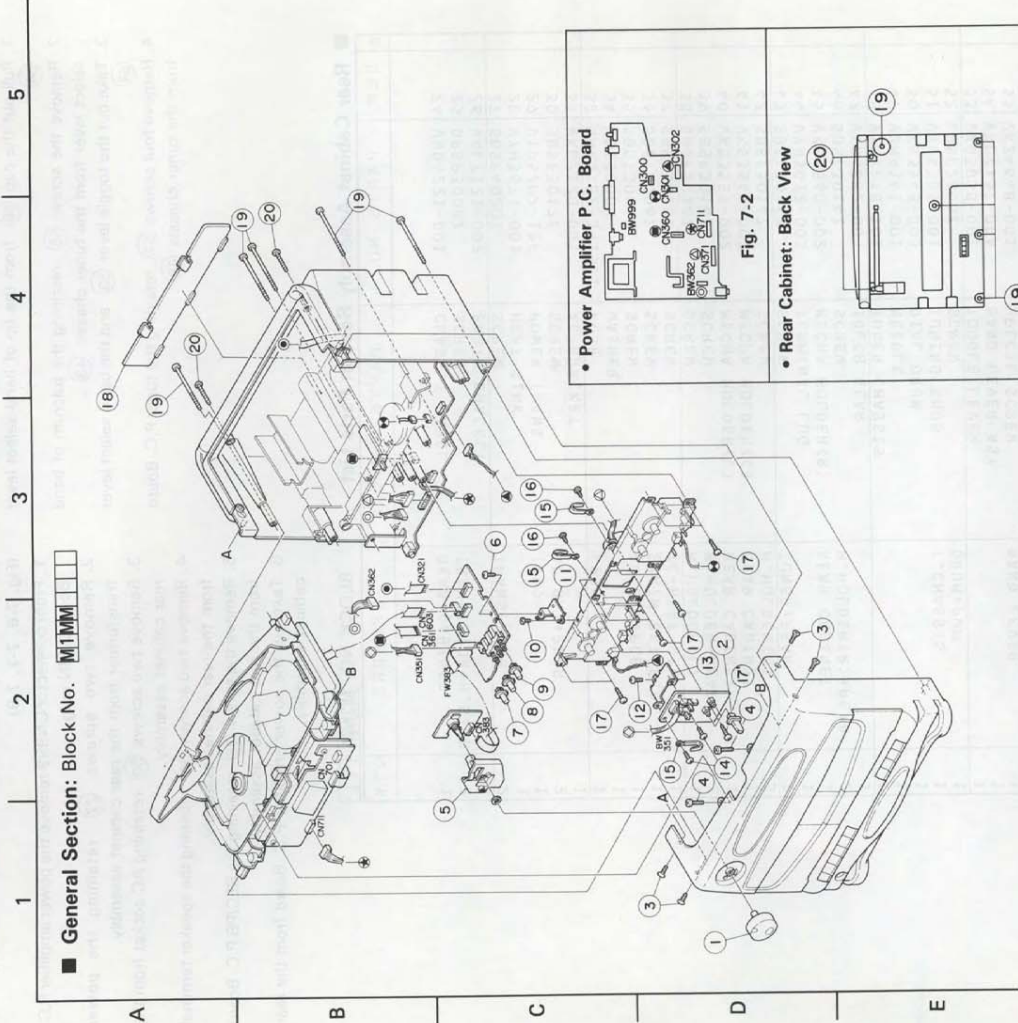

Fig. 6-4

7 Removal of Main Parts and Enclosure Parts List



■ **General Section:** Block No. **M1MM**

■ **Front Cabinet Assembly (Fig. 7-1, 7-3)**

1. Pull out the volume knob (1) from the front of set.
2. Take out the battery cover (18) from the back of set.
3. Remove five screws (19) x 5) from the back of set.
4. Remove four screws (3) retaining the both side of front cabinet assembly.
5. Push the disc holder button and open the disc holder.
6. Remove two screws (4) retaining the twin CD player assembly.
7. Keep the front of set and remove the front cabinet assembly, while open the Cassette door.
(Note: For further detailed developments (extensions), refer to Figs. 7-9 and 7-10 on Page 21).

■ **Twin CD Player Assembly (Fig 7-1, 7-2, 7-3)**

1. From connector CN711 remove the power Amplifier P.C. Board 11 PIN plug.
2. Remove two screws (20) retaining the twin CD player assembly from the back of set.
3. Pull out the twin CD player assembly this side of rear cabinet assembly.
4. Pull out the 5 PIN flat cable (to CD control P.C. Board) from the function P.C. Board (CN603).

■ **Function P.C. Board (Fig. 7-1, Fig. 7-2)**

1. From connector CN351 remove the Bass/Treble P.C. Board connector.
2. From connector CN321 remove the tuner P.C. Board 5 PIN flat cable.
3. From connector CN361 remove the power amplifier P.C. Board 12 PIN flat cable (to CN360)
4. From connector CN362 remove the function P.C. Board.
5. Remove the screw (6) retaining the function P.C. Board from the cassette mechanism.

■ **Cassette Mechanism Assembly (Fig. 7-1, 7-5)**

1. Remove eight screws (17) retaining the cassette mechanism from the rear cabinet assembly.
2. Take off the cassette mechanism.
3. From connector CN371 remove leaf switch and motor 10 PIN plug.
4. From connector CN301 remove playback head 3 PIN plug.
5. From connector CN302 remove Rec/playback head and Erase head 7 PIN plug.

■ **BASS/TREBLE P.C. Board (Fig. 7-1, 7-4)**

- Remove the screw (17) retaining the Bass/Treble P.C. Board from the cassette mechanism.

■ **General Section Parts List**

REF.	PARTS NO.	PARTS NAME	REMARKS	QTY
1	VXL4387-001	VOLUME KNOB		1
2	VXP5064-001	PUSH BUTTON	F-CABI SIDE	2
3	SSSF3010M	SCREW	F-CABI CD SIDE	2
4	SSSF3010M	SCREW	F-CABI CD UP	2
5	SDSF3012M	VOLUME HOLDER		1
6	SDSP3006Z	SCREW	FUNCTION BKT	1
7	VXP5063-001	PUSH BUTTON	CD MODE	1
8	VXP5063-002	PUSH BUTTON	TAPE MODE	1
9	VXP5063-003	PUSH BUTTON	TUNER MODE	1
10	SDST2005Z	SCREW	FUNCTION BKT	1
11	VKL7124-002	BRACKET	FUNCTION	1
12	SBST3006Z	SCREW	SEA BKT+MECHA	1
13	VKL7125-001	SEA BRACKET		1
14	SBST3006Z	SCREW	SEA BKT+SEA PCB	2
15	QHXS080-001	WIRE CLAMP		1
16	SBST3006Z	SCREW	SEA PCB+M-HOLDER	2
17	SBST3012Z	SCREW	SEA PCB+M-HOLDER	1
18	VJC2016-020	BATTERY COVER	MECHA+M-HOLDER	8
19	SBST3050Z	SCREW	F-CABI+R.CABI	1
20	SBST3020N	SCREW	CD ASS'Y+REAR	5

BLOCK NO. **M1MM**

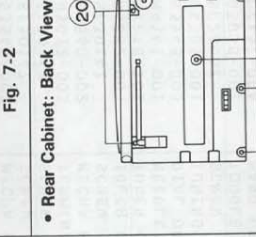
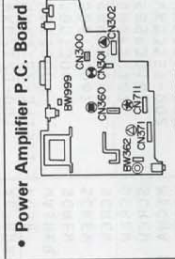
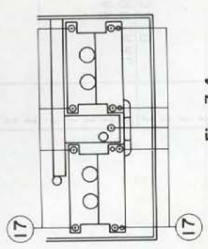

Fig. 7-1

Fig. 7-3

• **Cassette Mechanism: Front View**



• **Cassette Mechanism: Back View**

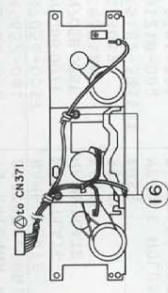

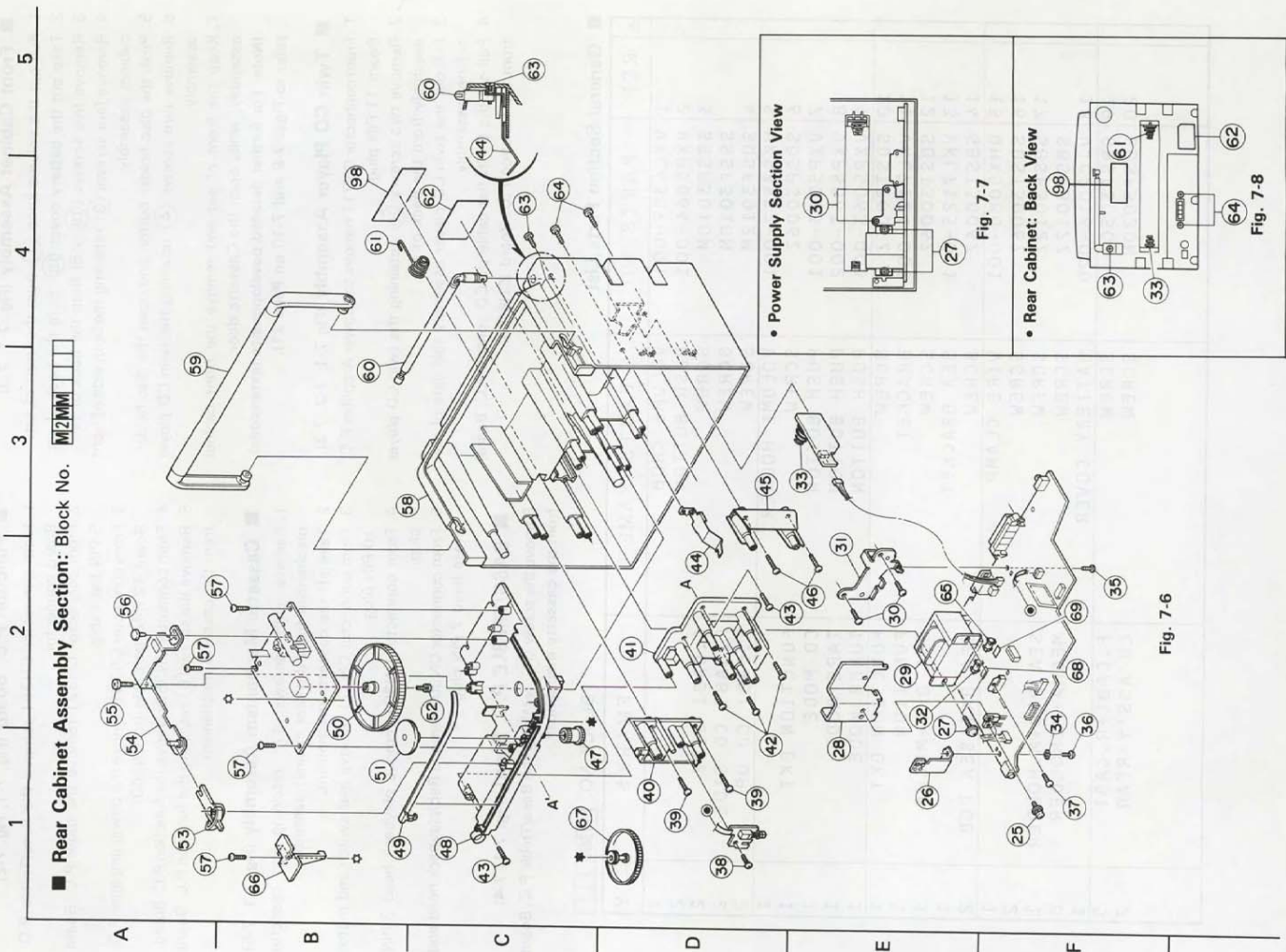

Fig. 7-6

Fig. 7-7

Fig. 7-8

■ Tuner P.C. Board Assembly (Fig. 7-6)

1. Pull out the cap (56) from the tip of band select lever (54).
2. Remove the screw (55) retaining the fulcrum of band select lever from the tuner chassis (48).
3. Take out the toggle lever (53) and the band select lever (54).
4. Remove four screws (57) retaining the tuner P.C. Board from the tuner chassis (48).

■ Power Amplifier P.C. Board Assembly (Fig. 7-6, 7-7, 7-8)

1. From connector CN999 remove the power amplifier P.C. Board 2 PIN plug.
2. Remove two screws (27) retaining the power transformer from the rear cabinet assembly.
3. Remove two screws (30) retaining AC socket from the rear cabinet assembly.
4. Remove two screws (64) retaining the speaker terminal from the rear cabinet assembly.
5. Remove the screw (38) retaining the REC/PB P.C. Board from the rear cabinet assembly.
6. Take out the power amplifier P.C. Board from the rear cabinet assembly.

■ Rear Cabinet Assembly Section Parts List

REF.	PARTS NO.	PARTS NAME	REMARKS	QTY
24	VND4221-001	CLASS 1 LABEL	REAR CABINET	1
25	DPSP3008Z	SCREW	TRANSISTOR+H.SINK	2
26	VKL7121-002	EARTH BRACKET	TRANS+REAR	1
27	GBSF4020Z	SCREW	T999	2
28	VYH3674-001	HEAT SINK	AC BKT+REAR	1
29	VIP57P2-12F	POWER TRANS	F998	1
30	SBSF3012Z	SCREW	AC BKT+PCB	1
31	VKL7120-001	AC BRACKET	IC+HEAT SINK	1
32	QMF51E2-3R15J1	FUSE	M.HOLDER(L)	1
34	WBS3000N	WASHER	M.HOLDER+REAR	1
35	SBST3006Z	SCREW	REAR CABINET	1
36	SBST3006Z	SCREW	M.HOLDER(R)+REAR	1
37	SBSF3008Z	SCREW	REAR CABINET	1
38	SBSF3012Z	SCREW	M.HOLDER(C)	1
39	SBSF3014Z	SCREW	TUNER+PEAR	2
40	VKS3559-002	MECHA HOLDER(L)	REAR CABINET	1
41	VKS3549-002	MECHA HOLDER(C)	REAR CABINET	1
42	SBSF3014Z	SCREW	M.HOLDER(C)	1
43	SBSF3014Z	SCREW	TUNER+PEAR	2
44	VYH5012-005	TERMINAL LUG	REAR CABINET	1
45	VKS3560-002	MECHA HOLDER(R)	M.HOLDER(R)+REAR	1
46	SBSF3014Z	SCREW	REAR CABINET	2
47	VKR4682-001	IDLER GEAR	REAR CABINET	1
48	VYH1218-101	TUNER CHASSIS	T.CHASSIS	1
49	VJN4141-001	NEEDLE	DRUM+PWB	1
50	VKS3548-003	DIAL DRUM	BAND LEVER	1
51	VXL4385-001	TUNING KNOB	BAND LEVER	1
52	LSP2606Z	SCREW	T.CHASSIS	4
53	VXQ3058-001	TOGGLE LEVER	DRUM+PWB	1
54	VKL7137-00A	BAND LEVER ASY	BAND LEVER	1
55	VKZ4648-001	SPECIAL SCREW	BAND LEVER	1
56	VYH4034-003	STUD	T.CHASSIS	1
57	SBSF3012Z	SCREW	PC-XT3 B/E	4
58	VJG1012-002	REAR CABINET	PC-XT3 G	1
59	VJG1012-004	REAR CABINET	PC-XT3 G	1
60	VJH4121-00A	HANDLE ASS'Y	PC-XT3 E	1
61	VJA3006-00E	T. ANTENNA ASSY	PC-XT3 B	1
62	VYH5657-001	BATTERY SPRING	ROD ANT+REAR	1
63	VYH7056-005T	NAME PLATE	SPEAKER TERMINAL	2
64	VYH7056-007T	NAME PLATE	F997:PC-XT3E/B	1
65	SDSP3012N	SCREW	F998	1
66	SBSF3012N	SCREW	F997:PC-XT3E/B	1
67	QMF51E2-3R15J1	FUSE	F998	1
68	VYH1218-002	NEEDLE HOLDER	F997:PC-XT3E/B	1
69	VXL4386-001	F TUNING KNOB	F997:PC-XT3E/B	1
69	VND4003-053	FUSE LABEL	F997:PC-XT3E/B	1

■ Operation button (Fig. 7-9, 7-10)

1. Remove seven screws (96) retaining the both side button bracket (95) from the front cabinet (82).
2. Remove four screws (86) retaining the CD button (A) and (B) from the front cabinet (82).
3. Remove the screw (84) retaining the power button (83) from the front cabinet (82).

■ Front Cabinet Assembly Section: Block No. M3MM

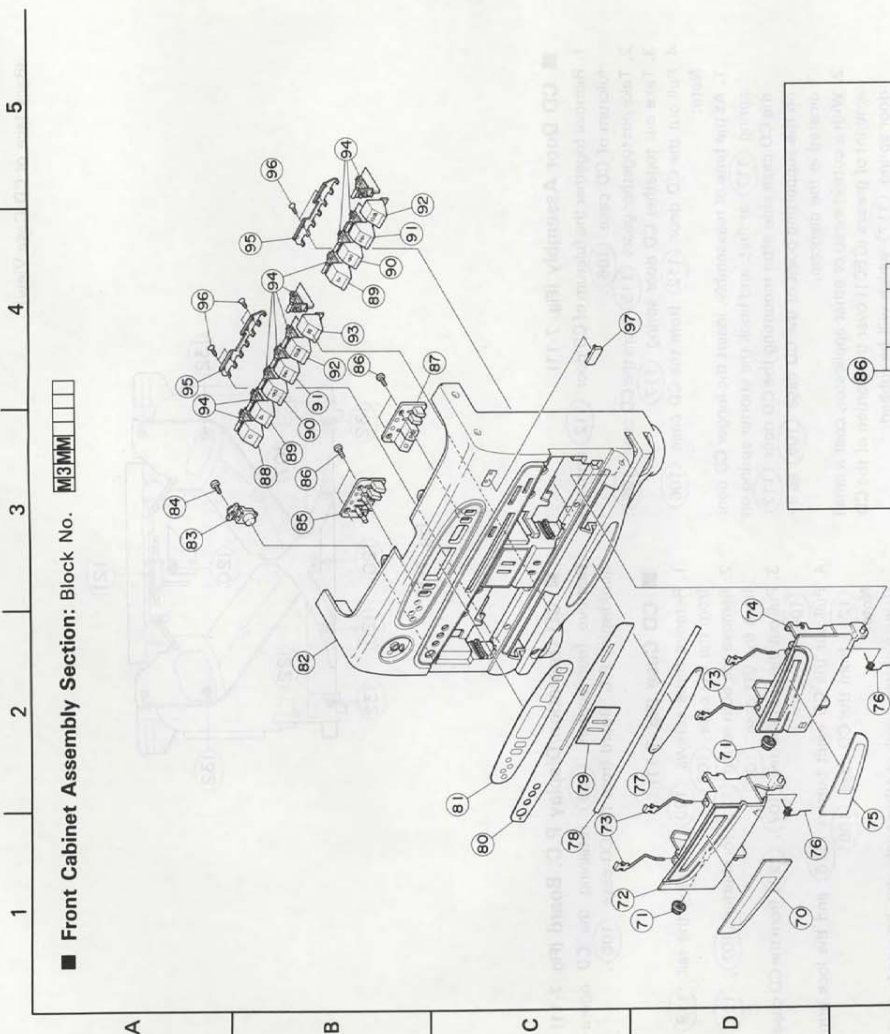

Fig. 7-9

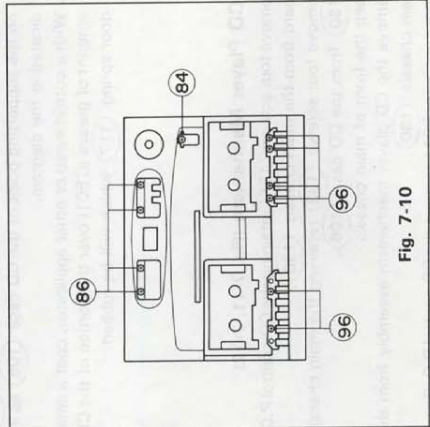

Fig. 7-10

■ Front Cabinet Assembly Section Parts List

REF.	PARTS NO.	PARTS NAME	REMARKS	QTY
77-82, 97	ZCPRXT3B-FBK	FRONT CABINET ASS'Y	PC-XT3 B	1
77-82, 97	ZCPRXT3E-FBK	FRONT CABINET ASS'Y	PC-XT3 E	1
70, 72, 73	ZCPRXT3G-FBK	FRONT CABINET ASS'Y	PC-XT3 G	1
74, 75, 73	ZCPRXT3K-CBKA	CASSETTE CASE ASS'Y		1
70	ZCPRXT3K-CBKB	CASSETTE CASE ASS'Y		1
70	VJT3319-001	CASSETTE LENS		1
71	VYH5601-001	GEAR		1
71	VYH5601-001	GEAR		1
72	VJT2276-111	CASSETTE DOOR(A)		1
73	VKY4180-001	CASSETTE SPRING		2
74	VKY4180-001	CASSETTE SPRING		2
74	VJT2276-002	CASSETTE DOOR		1
75	VJT3319-002	CASSETTE LENS		1
76	VYH7214-002	DOOR SPRING		1
76	VYH7214-002	DOOR SPRING		1
77	VJD5352-001	PLATE	SUPER BASS HORN	1
78	VJD3885-001	CONTROL PLATE		1
79	VJD5361-001	CENTER LENS		1
80	VJK3564-002	DIAL LENS		1
81	VJD3884-001	LCD LENS		1
82	VJG1013-002	FRONT CABINET		1
83	VXP5062-001	POWER BUTTON		1
84	SDSF2608Z	SCREW	F. CABINET	1
85	VXP3444-003	CD BUTTON(A)		1
86	SDSF2606Z	SCREW		4
87	VXP3445-002	CD BUTTON(B)		1
88	VXP3348-101	MECHA BUTTON	A: REC	1
89	VXP3348-103	MECHA BUTTON	A,B: PLAY	2
90	VXP3348-104	MECHA BUTTON	A,B: REW	2
91	VXP3348-105	MECHA BUTTON	A,B: FF	2
92	VXP3348-106	MECHA BUTTON	A,B: STOP	2
93	VXP3348-107	MECHA BUTTON	A: PAUSE	1
94	VKS5375-001	BUTTON LEVER		10
95	VKL6107-003	BUTTON BRACKET		2
96	SDSF2606Z	SCREW		6
97	VJD4027-001	JVC MARK		1

(Back face of CD Case View)

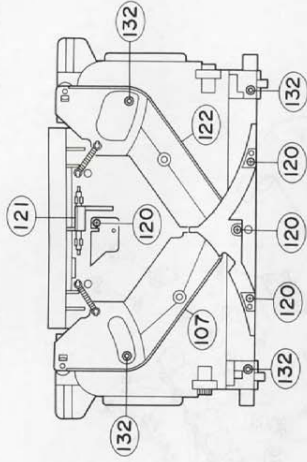

Fig. 7-12

■ CD Door Assembly (Fig. 7-11)

1. Remove together the fulcrum of CD door (112) from the fulcrum of CD case (106).
2. Take out together gears (115) from the CD case (106).
3. Take out together CD door spring (117).
4. Pull out the CD door (112) from the CD case (106).

Note:

1. At the time of reassembly, insert the longer CD door spring (117) at first, and hook the shorter spring on the CD case side after mounting the CD door (112) on the supporting point of the CD case (106) as indicated in the diagram.
2. With a cotton swab or other applicator, coat a small amount of grease (G501) over the portion of the CD door spring (117) which will be rubbed.

■ CD Operation/Display P.C. Board (Fig. 7-11)

Remove four screws (105) retaining the CD operation/display P.C. Board from the CD case (106).

■ CD Case (Fig. 7-11)

1. Remove three screws (120) retaining the rail (119) from the CD case (106).
2. Remove the both spring (123) for shutter (107), (122) from the CD case (106).
3. Pull out the both shutter (107), (122) from the CD case (106).
4. Pull out the CD eject button (116) and the lock arm (121) from the CD case (106).

Note:

Using a cotton swab or other applicator, be sure to coat a small amount of grease (G501) on both of the shutters (107) and (122).

Notes

1. When the CD player mechanism is reassembled with the sub chassis (100), be sure to arrange the insulator (grey) (101) and insulator (black) (102) correctly without mistake in compliance with the diagram.
2. The respective connectors of 4 PIN, 6 PIN and 10 PIN after the CD player mechanism has been assembled with the sub chassis. In this case, connect the respective connectors after twisting the 4 PIN connectors (Subsequent to treatment) (101) and (102) respectively connectors, pass the treatment of the supporting arm the diagram.
3. For (Subsequent to treatment) (101) and (102) respectively connectors, pass the treatment of the supporting arm the diagram.

■ CD Player Mechanism (Fig. 7-11, 7-12)

1. Remove four screws (131) retaining the CD control P.C. Board from the main chassis (130).
2. Remove four screws (132) retaining the main chassis (130) from the CD case (106).
3. Keep the front of main chassis.
4. Remove the CD player mechanism assembly from the main chassis (130).
5. From connector P011 remove the CD control P.C. Board 6 PIN plug.
6. From connector P001 remove the CD control P.C. Board 10 PIN plug.
7. From connector P002 remove the CD control P.C. Board 4 PIN plug.

■ Twin CD Player Section! Block No. M4MM

Free service information

www.ficcoff.com

Free service information

1 2 3 4 5

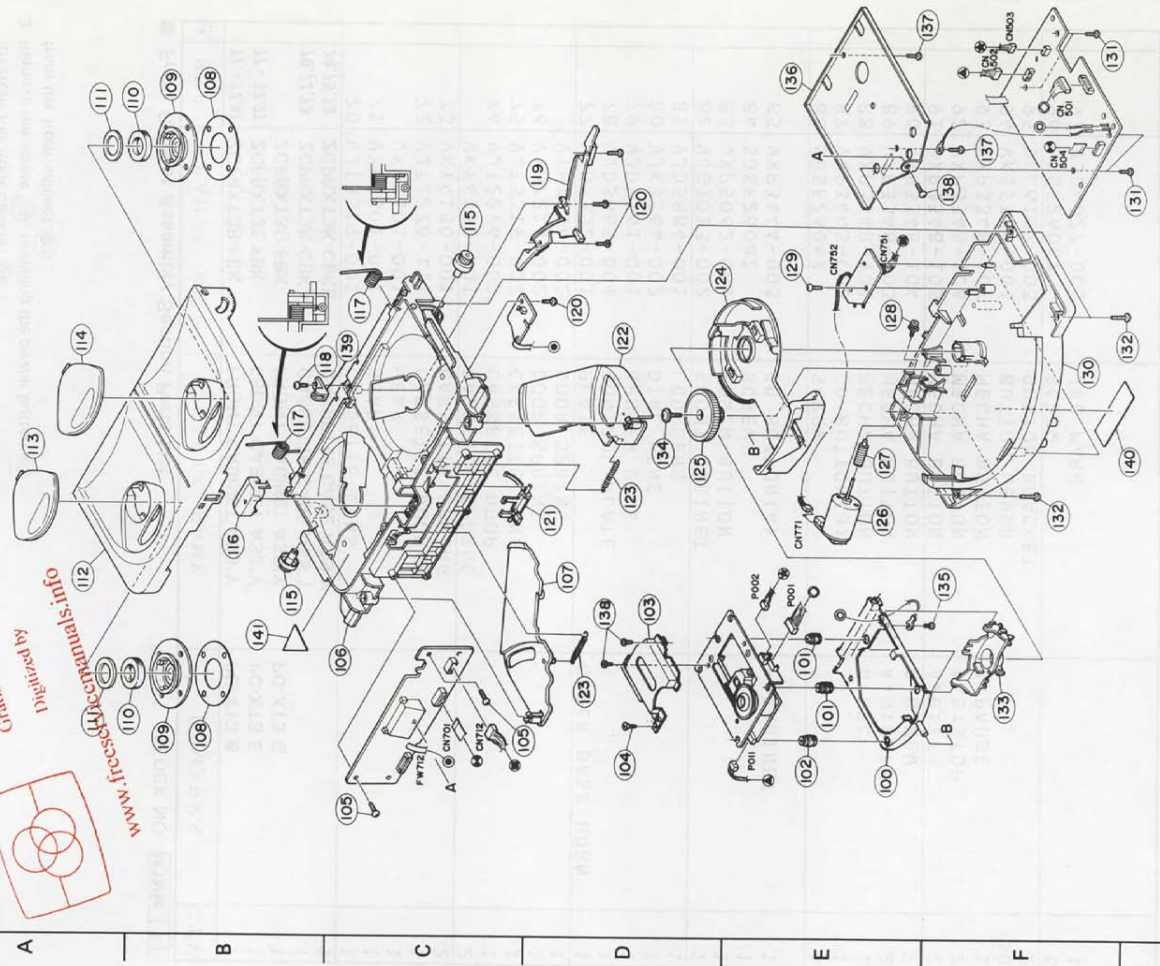
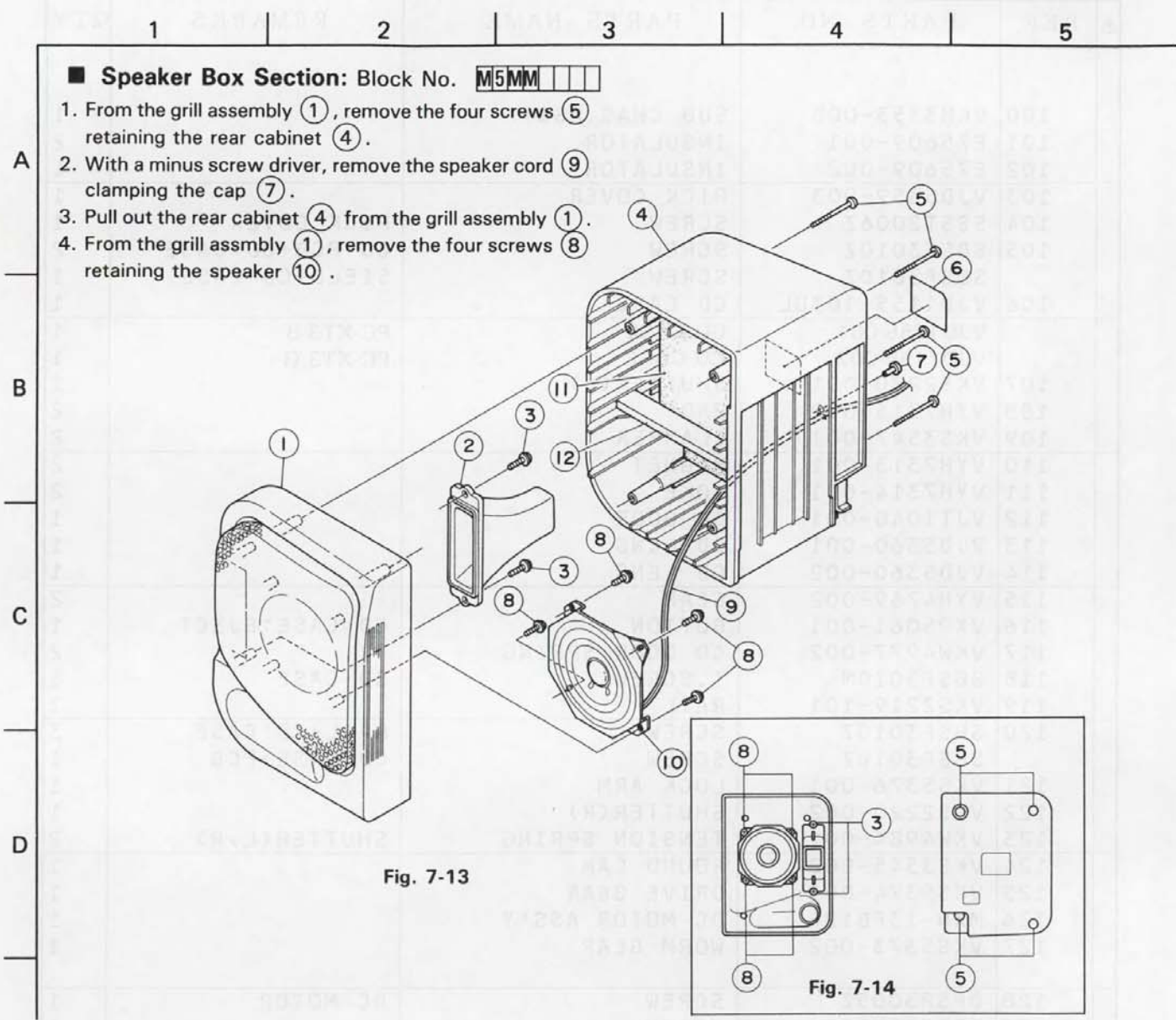

Fig. 7-11

■ Twin CD Player Section Parts List

BLOCK NO. M4MM

△	REF.	PARTS NO.	PARTS NAME	REMARKS	QTY
	100	VKM3553-00B	SUB CHAS.ASSY		1
	101	E75609-001	INSULATOR		2
	102	E75609-002	INSULATOR		1
	103	VJD5359-003	PICK COVER		1
	104	SSST2006Z	SCREW	PICK COVER	1
	105	SBSF3010Z	SCREW	CD PCB+CD CASE	2
		SBSF3010Z	SCREW	SHIELD+CD CASE	1
	106	VJD1155-103UL	CD CASE		1
		VJD1155-001	CD CASE	PC-XT3 B	1
		VJD1155-002	CD CASE	PC-XT3 G	1
	107	VKS2220-001	SHUTTER(L)		1
	108	VYH7315-002	PAD		2
	109	VKS3547-001	CLAMPER		2
	110	VYH7313-001	MAGNET		2
	111	VYH7314-001	YOKE		2
	112	VJT1040-001	CD DOOR		1
	113	VJD5360-001	CD LENS		1
	114	VJD5360-002	CD LENS		1
	115	VYH4769-002	GEAR		2
	116	VXP5061-001	BUTTON	CD CASE:EJECT	1
	117	VKW4977-002	CD DOOR SPRING		2
	118	SBSF3010M	T.SCREW	CD CASE	1
	119	VKS2219-101	RAIL		1
	120	SBSF3010Z	SCREW	RAIL+CD CASE	3
		SBSF3010Z	SCREW	CD CASE+PCB	1
	121	VKS5376-001	LOCK ARM		1
	122	VKS2220-002	SHUTTER(R)		1
	123	VKW4984-001	TENSION SPRING	SHUTTER(L,R)	2
	124	VKS3545-002	ROUND CAM		1
	125	VKS5374-001	DRIVE GEAR		1
	126	MXN-13FB12F	DC MOTOR ASS'Y		1
	127	VKS5373-002	WORM GEAR		1
	128	DPSP3005Z	SCREW	DC MOTOR	1
	129	SBSF3008Z	SCREW		1
	130	VKS1123-001	MAIN CHASSIS		1
	131	SBSF3014Z	SCREW	CD PCB+M.CHASSIS	4
	132	SBSF3012Z	SCREW	CD CASE	4
	133	VKS3546-001	SUPPORT ARM		1
	134	E65923-003	T.SCREW		1
	135	SDST2604Z	SCREW		2
	136	VMA3194-001	SHIELD	MAIN CHASSIS	1
	137	SBSF3008Z	SCREW	SHIELD+M.CHASSIS	2
	138	SDST2006Z	TAPPING SCREW	PICK COVER	2
	139	VKS2219-002	CENTER FULCRUM		1
	140	VND4220-001	LASER CAUTION	MAIN CHASSIS	1
	141	E71541-001	E.I.LASER MARK	CD CASE UP	1



■ Speaker Box Parts List

BLOCK NO. M5MM

△	REF.	PARTS NO.	PARTS NAME	REMARKS	QTY
	1	VJC2430-00A VJC2430-00B	Front Panel Ass'y (L) " (R)	Left Side Right Side	1 1
	2	VYH3697-001	Dust	L/R Side	2
	3	GBSF3010Z	Screw	For Duct	2
	4	VJG1019-001 VJG1019-002	Rear Cabinet (L) " (R)	Left Side Right Side	1 1
	5	SBSF3045Z	Screw	Front + Rear: L/R	8
	6	VYN7056-001B	Name Plate	L/R Side	2
	7	VJD5373-001SS	Stopper	L/R Side	2
	8	GBSF3010Z	Screw	For Speaker: L/R	8
	9	VMP0040-002T	Speaker Cord	L/R	2
	10	EAS-10P457A-G	Speaker	SP101, SP201: L/R	2
	11	VKZ4658-001	Sound Absorber	L/R	2
	12	VYH3710-001	Stay	L/R	2

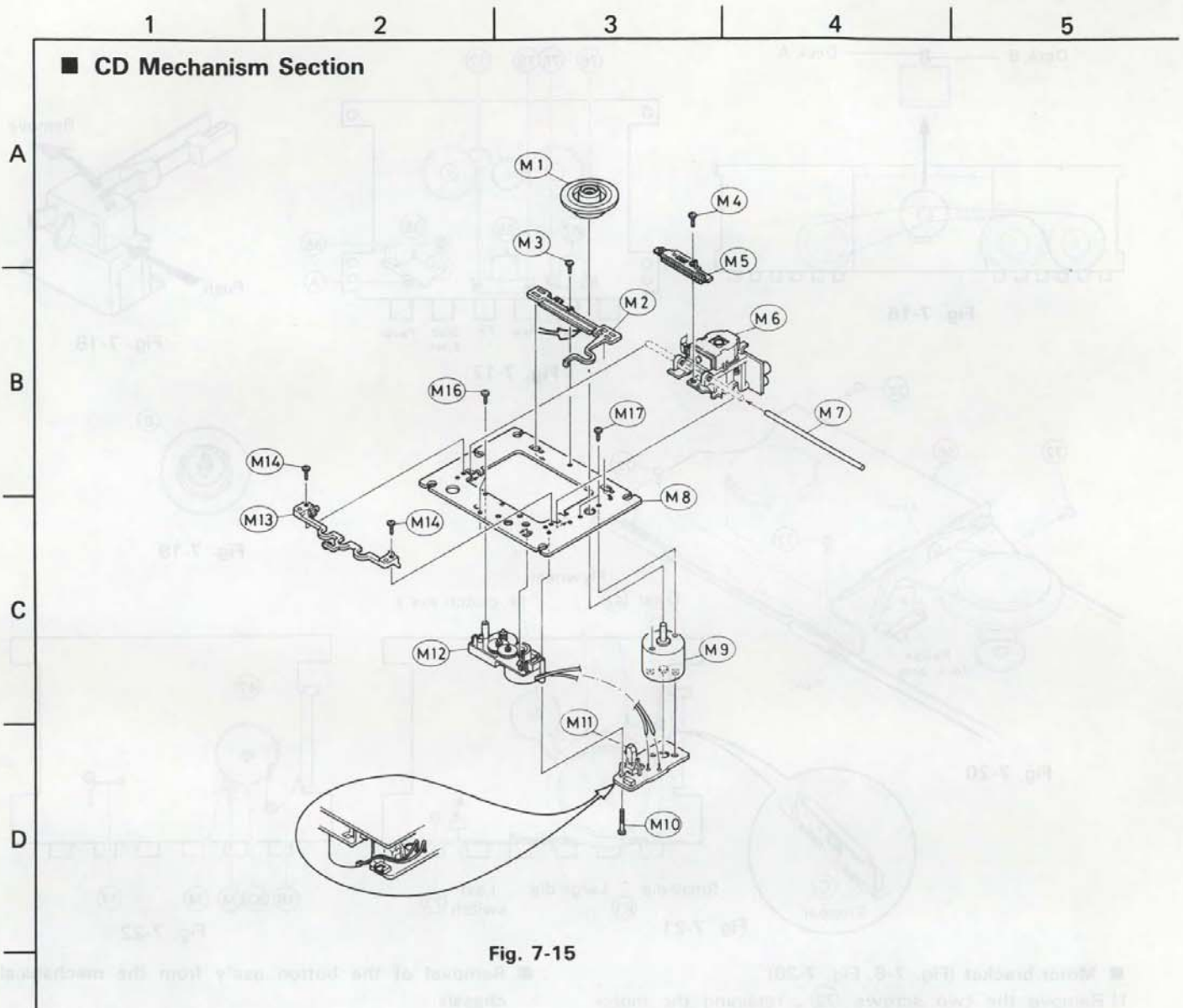
**■ CD Mechanism Parts List**BLOCK NO. M6MM

△	REF.	PARTS NO.	PARTS NAME	REMARKS	QTY
	M1	E406064-002	CD Turn Table Ass'y		1
	M2	E306275-003	CD Support		1
	M3	SDST2005Z	Screw		1
	M4	SPSH2050M	Screw		1
	M5	E306282-001	CD Lock Ass'y		1
	M5	OPTIMA-5S	Pick Up Unit		1
	M7	E74930-003	Shaft	For Pick Up	1
	M8	E26487-003	Chassis Base		1
	M9	E74539-001B	Spindle Motor		1
	M10	E75832-001	Screw	For Leaf Switch	1
	M11	ESB1100-005	Leaf Switch		1
	M12	SE10351-11	Gear Ass'y		1
	M13	E306277-001	Screw		1
	M14	SDST2004Z	Screw		1
	M16	E72713-001	Screw		1
	M17	SDSP2003N	Screw		2

■ Mechanism Section

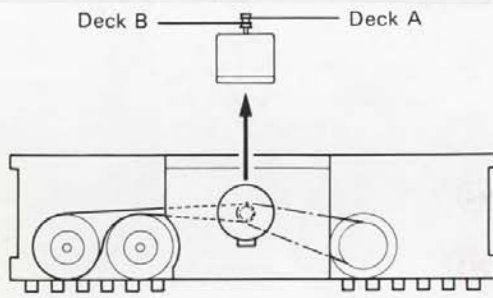

Fig. 7-16

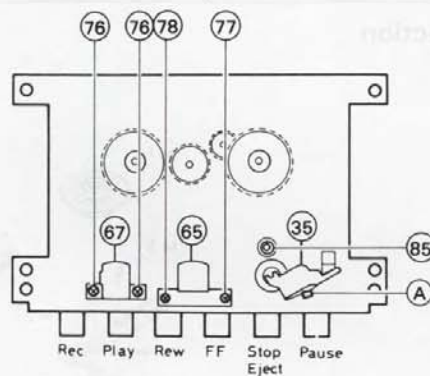

Fig. 7-17

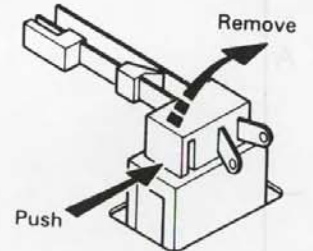

Fig. 7-18

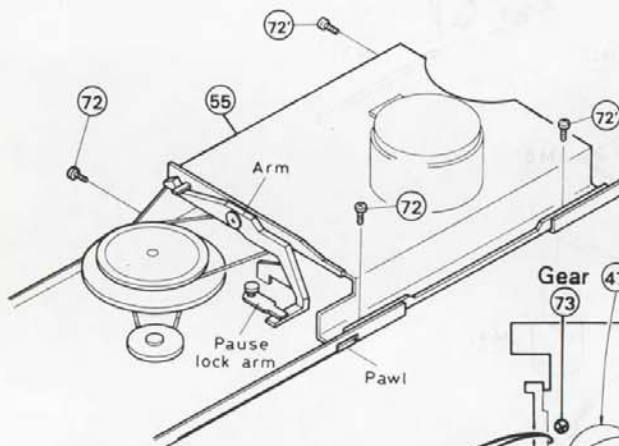

Fig. 7-20

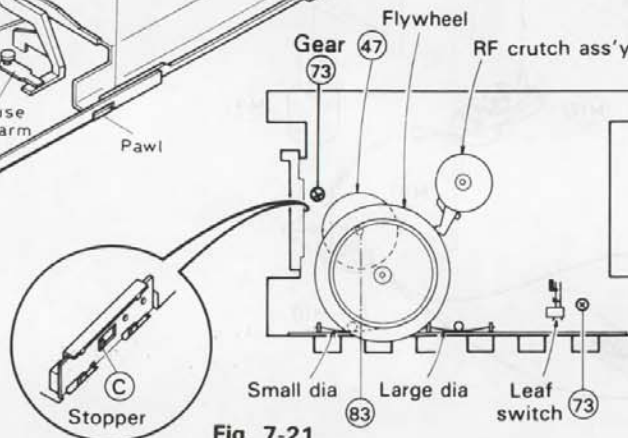

Fig. 7-21

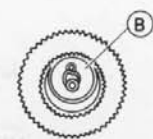

Fig. 7-19

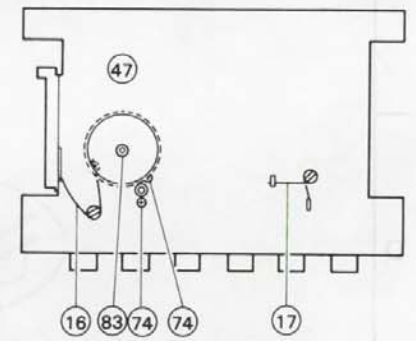

Fig. 7-22

■ Motor bracket (Fig. 7-6, Fig. 7-20)

- 1) Remove the two screws (72), retaining the motor bracket.
- 2) Remove (72') and (72') retaining the motor bracket (55).
- 3) Remove the chassis and motor bracket from the button side.

Then remove the bracket arm (panel).

(The synchro arm can be removed from the pause lock. Return the pause lock after it is removed from the proper position.)

■ Recording/playback head (65) and Erase head (67) (Fig. 7-17)

- 1) Remove two screws (71), (78) retaining the recording/playback head (65).
- 2) Remove two screws (76) retaining the erase head (67).

■ Pinch roller Ass'y (Fig. 7-17)

Remove the pinch roller arm stopper (A).

■ Flywheel ass'y (44) or (43) (Fig. 7-17)

- 1) Remove the poly washer (85) securing the capstan shaft.
- 2) Pull out the flywheel ass'y (44) or (43).

■ Removal of the button ass'y from the mechanical chassis.

- Leaf switch (Fig. 7-18)
Press the switch's lock panel and raise from the left to remove.
- Gear (47) ... Below the flywheel (Fig. 7-19, Fig. 7-21)
Remove the C washer (83) securing the gear (47). For reassembly, insert the Sensing Lever arm stand into the (B) section.
- Lock arm (Fig. 7-21)
Press the arm stopper from window (C), and pull to remove.
- Chassis removal (Fig. 7-22)
 - 1) Remove the three springs (16), (17).
 - 2) Remove the two screws (73).
 - 3) Remove the two screws (74) securing the capstan metal.
 - 4) Gently remove the button ass'y from the chassis.

■ Cassette Mechanism Section Parts List

BLOCK NO. **M7MM**

REF.	PARTS NO.	PARTS NAME	REMARKS	QTY
1	192114301T	BASE ASS'Y		2
2	19211409T	SWITCH PLATE		2
3	19211438T	LOCK CAM		2
4	19211422T	BUTTON LEVER	REC	1
5	19211423T	BUTTON LEVER	PLAY	2
6	19211424T	BUTTON LEVER	REW	2
7	19211425T	BUTTON LEVER	FF	2
8	19211426T	BUTTON LEVER	STOP	2
9	19211427T	BUTTON LEVER	PAUSE	1
10	19211413T	TORSION SPRING	PINCH ROLLER	1
11	19211410T	PAUSE LEVER		1
12	19211412T	SPRING	PAUSE LEVER	1
13	19211411T	PAUSE STOPPER		1
14	19211414T	TORSION SPRING	FF, REW: BUTTON LEVER	2
15	192101501T	CHASSIS ASS'Y		2
16	19211416T	TORSION SPRING	EJECT ACTUATOR	2
17	19211417T	TORSION SPRING	PLAY: PAUSE STOPPER	2
19	182101159T	E-KICK LEVER		2
20	19211420T	STOPPER		2
21	19211421T	TORSION SPRING	PINCH ROLLER	1
23	640101149T	LEAF SWITCH	REC	2
24	19211414T	TORSION SPRING	MSW-1541T	2
25	19210301T	HEAD PANEL	STOP	1
26	19210302T	HEAD PANEL		1
27	19210304AT	HEAD BASE		1
28	19210306T	HEAD BASE		1
29	19210303T	TENSION SPRING		2
30	19211418T	TORSION SPRING	SENSING LEVER	2
31	19211434T	P-ROLLER ARM		1
33	18210308T	SPRING	ERASE HEAD	1
34	18210307T	AZIMUTH SPRING		2
35	192104301T	P-ROLLER ASS'Y		2
38	19212604T	SENSING LEVER		2
39-1	192107302T	RF CLUTCH ASS'Y		1
39-2	192107301T	RF CLUTCH ASS'Y		1
40	19210703T	REW/F.F. BELT		2
43	192109304T	FLYWHEEL ASS'Y		1
44	192109303T	FLYWHEEL ASS'Y		1
45	19212605T	TORSION SPRING	GEAR PLATE	2
46	192126502T	GEAR PLATE ASY.		1
47	19212602T	CAM GEAR		2
48	192126501T	GEAR PLATE ASY.		1
49	18211070T	F. FORWARD GEAR		2
50	18291010T	BACK TENS. SP.		2
51	192105302T	SUPPLY REEL ASY		2
52	192105301T	T-UP REEL ASY'Y		2
53	19210506T	SENSOR		2
55	19211210T	MOTOR BRACKET		1
56	18201306T	RUBBER CUSHION		3
57	18211202T	COLLAR SCREW		3
59	19210906T	MAIN BELT		2
60	18201354T	MAT (MECHA.A)		2
61	19211212T	MAT		1
62	19211302T	EJ. SLIDE LEVER		2

■ Cassette Mechanism Section: Block No. M7MM

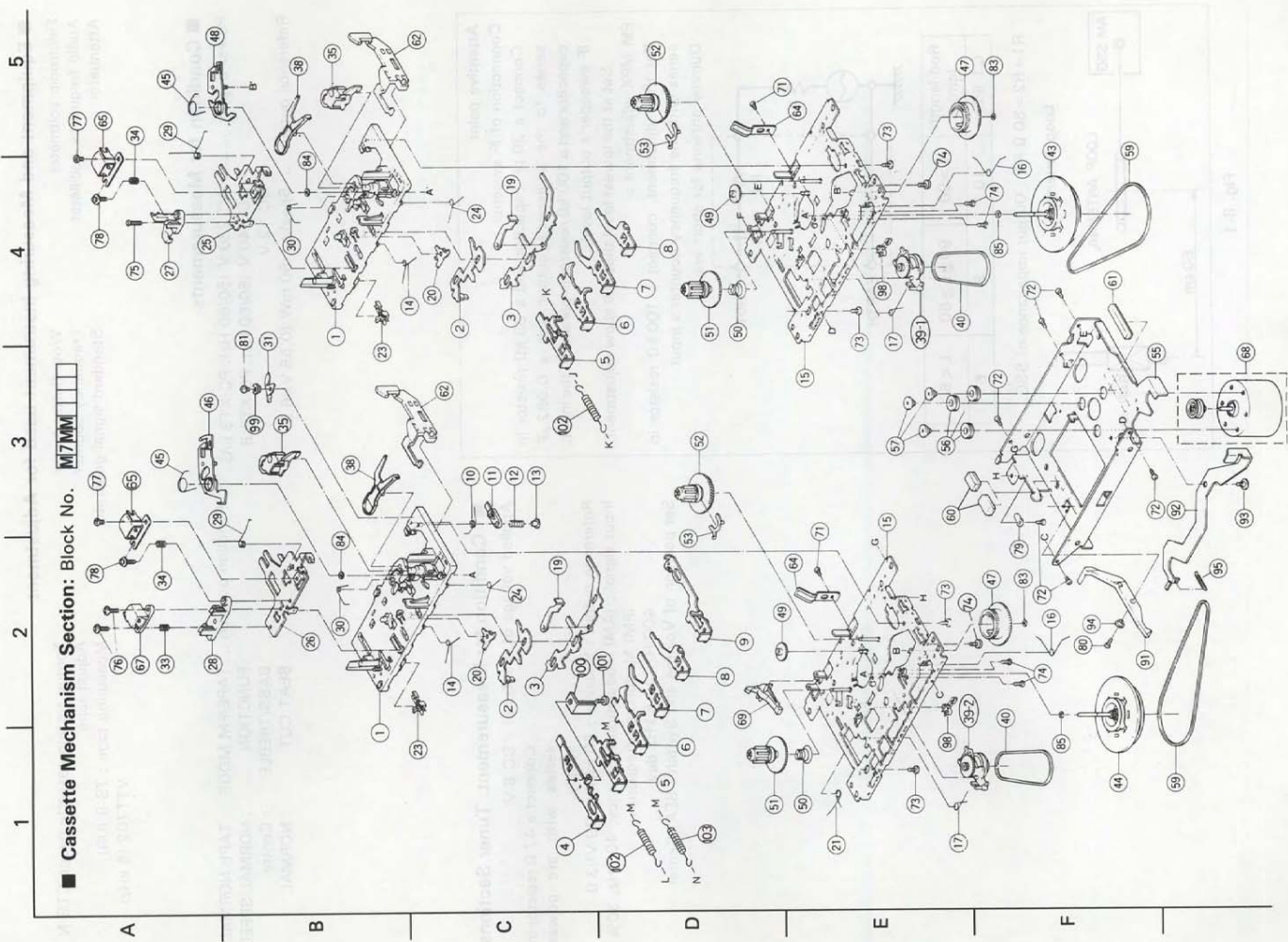

8 Main Adjustment

Equipment and Measuring Instrument used for Adjustment

- Electronic voltmeter
- Wow-flutter meter
- Audio frequency oscillator
- Attenuator
- Standard signal generator
- Torque testing cassette gauge CTG-N
- Adjust tape
- Measuring tape : TS-8 (UR) VTT702 (8 kHz)

Condition for Measurements

- Power Supply : AC 230 V (50/60 Hz); PC-XT3 E/G
- AC 240 V (50/60 Hz); PC-XT3 B
- DC 12 V
- Reference output : Speaker : 50 mW (0.55 V)/6 Ω
- Function position : TAPE/FM MODE : TAPE NORMAL
- FUNCTION : NORMAL SPEED
- BASS/TREBLE : Centre
- BEAT CUT : NORMAL

Condition for Measurement: Tuner Sections

- Applied voltage of the Tuner : DC 8 V
- Connect a 47 Ω resistor in series with are power supply.
- Reference output : Speaker ; 50 mW (0.39 V)/3 Ω
- Input signal : (AM) modulation frequency: 400 Hz, 30% (FM) Modulation frequency; 400 Hz, 22.5 kHz dev.
- Set position of Volume and Switch : SEA; Center

REF.	PARTS NO.	PARTS NAME	REMARKS	QTY
64	18291001T	PACK SPRING		2
65	VGH0421-020	R / P HEAD		2
67	ENZ6004-006	E HEAD		1
68	192112318T	MOTOR ASS'Y		1
69	182110691T	REC.SAF.LEVER		1
71	91790000T	TAPPING SCREW	M2 X 3; PACK SPRING	2
72	91800000T	TH.TAP.SCREW	M2 X 4	6
73	96790000T	TAPPING SCREW	2 X 5	4
74	99991809T	SPECIAL SCREW	2 X 4.5	6
75	90040000T	SCREW(M2 X 6)	M2 X 6	2
76	92230000T	CAP SCREW	M2 X 7.5	1
77	91150000T	SCREW(M2 X 3)	M2 X 3; R/P HEAD	2
78	99220000T	SCREW(M2 X 7)	M2 X 7; AZIMUTH	2
79	94800000T	LUG		1
80	91820000T	SCREW	M2 X 6	1
81	99992018T	SPECIAL SCREW		1
83	94220000T	POLY.CUT WASHER	1.2 X 3.8 X 0.3	2
84	99990313T	POLY.CUT WASHER	1.45 X 3.8 X 0.5	2
85	97860000T	POLY WASHER	2 X 3.5 X 0.3	2
91	19211209T	P KICK LEVER B		1
92	182112154T	P KICK LEVER A		1
93	18211223T	COLLAR SCREW		1
94	18211265T	COLLAR		1
95	18211225T	SPRING		1
98	640101161T	LEAF SWITCH	P KICK LEVER A	2
99	19211437T	P.ARM COLLER		1
100	15100212T	REC SPRING PLATE		1
101	91790000T	SCREW		1
102	18210150T	SCREW	REC SPRING PLATE	2
103	18211311T	SCREW	PLAY BUTTON LEVER EJECT SLIDE LEVER	1

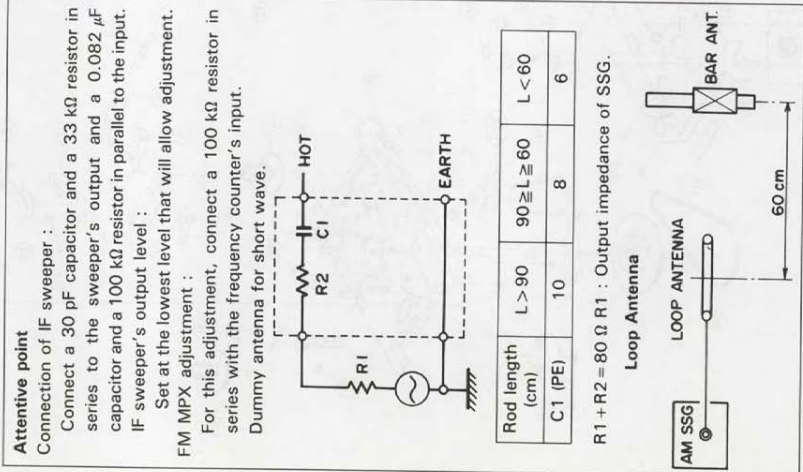
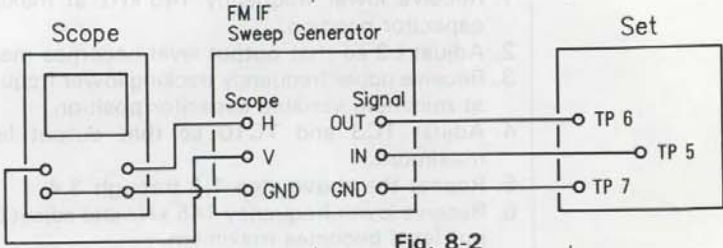
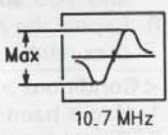
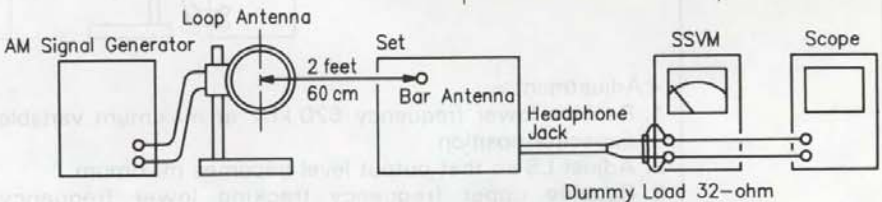
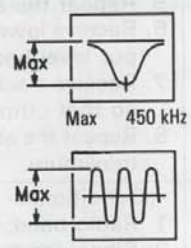
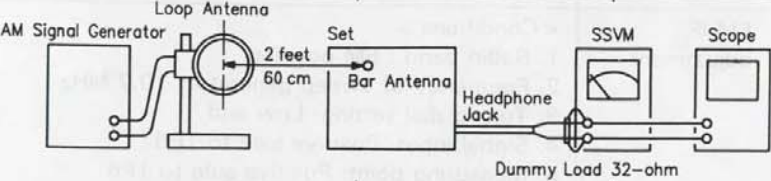
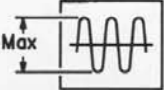
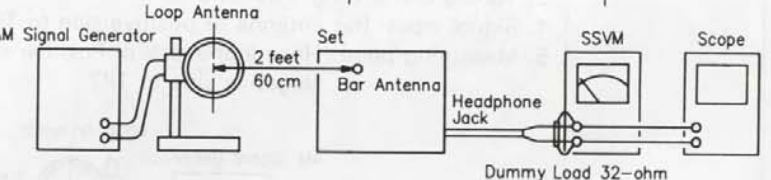
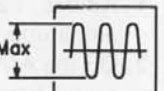

Fig. 8-1

Free service manuals
Gratis schema's
Digitized by
www.freesevicemanuals.info

■ Main Adjustment: Tuner Section

Item	Measuring Conditions and Main Adjustment	Standard Value	Adjust
FM IF adjustment	<p><Conditions></p> <ol style="list-style-type: none"> 1. Radio band : FM position 2. Frequency of sweep generator: 10.7 MHz 3. Tuning dial setting: Low end 4. Signal input: Positive side to TP5 5. Measuring point: Positive side to TP6 Negative side to TP7  <p><Adjustment></p> <p>Adjust T1 obtain "S" curve and maximum amplitude.</p> <p><Note></p> <p>Ceramic filter unit has colour mark on the body that expressed its center frequency. Classification of ceramic filter. Colour marking: Red frequency: 10.70 ± 0.03 MHz</p> 		T1
MW IF adjustment	<p><Conditions></p> <ol style="list-style-type: none"> 1. Radio band: MW position 2. Frequency of signal generator: 450 kHz 3. Tuning dial setting: Low end 4. Signal input: Bar antenna or positive side to TP3 5. Measuring point: Headphone jack or Positive side to TP6 Negative side to TP7  <p><Adjustment></p> <ol style="list-style-type: none"> 1. Adjust T2 obtain symmetrical curve and maximum amplitude. 2. On the AM IF Circuit in case where IF filter was used solid units there is unnecessary for IF turning and IF character depend upon the ceramic filter unit. 		T2
LW tracking adjustment	<p><Conditions></p> <ol style="list-style-type: none"> 1. Radio band: LW position 2. Signal input: Bar antenna 3. Frequency of signal generator: <ul style="list-style-type: none"> 145 kHz (Tuning dial setting: low end) 290 kHz (Tuning dial setting: high end) 145 kHz (Tuning dial setting: 145 kHz) 290 kHz (Tuning dial setting: 290 kHz) 4. Measuring point: Headphone jack 		

Item	Measuring Conditions and Main Adjustment	Standard Value	Adjust
	 <p data-bbox="427 477 603 499"><Adjustment></p> <ol data-bbox="427 506 1098 869" style="list-style-type: none"> 1. Receive lower frequency 145 kHz at maximum variable capacitor position. 2. Adjust L3 so that output level becomes maximum. 3. Receive upper frequency tracking lower frequency 290 kHz at minimum variable capacitor position. 4. Adjust TC3 and TC10 so that output level becomes maximum. 5. Repeat the above step 1,2 through 3,4. 6. Receive lower frequency 145 kHz and adjust L4 so that output level becomes maximum. 7. Receive tracking upper frequency 290 kHz and adjust TC4 and TC9 so that output level becomes maximum. 8. Repeat the above step 6. through 7. so that output becomes maximum. 	<p data-bbox="1161 472 1257 495">Fig. 8-6</p>  <p data-bbox="1193 819 1289 842">Fig. 8-7</p>	<p data-bbox="1449 510 1485 533">L3</p> <p data-bbox="1406 611 1528 633">TC3,TC10</p> <p data-bbox="1449 723 1485 745">L4</p> <p data-bbox="1406 801 1528 824">TC4,TC9</p>
<p data-bbox="228 887 379 931">MW tracking adjustment</p>	<p data-bbox="427 887 587 909"><Conditions></p> <ol data-bbox="427 916 946 1122" style="list-style-type: none"> 1. Radio band: MW position 2. Signal input: Bar antenna 3. Frequency of signal generator: <ul style="list-style-type: none"> 520 kHz (Tuning dial setting: low end) 1650 kHz (Tuning dial setting: high end) 600 kHz (Tuning dial setting: 600 kHz) 1400 kHz (Tuning dial setting: 1400 kHz) 4. Measuring point: Headphone jack  <p data-bbox="427 1323 603 1346"><Adjustment></p> <ol data-bbox="427 1352 1098 1686" style="list-style-type: none"> 1. Receive lower frequency 520 kHz at maximum variable capacitor position. 2. Adjust L5 so that output level becomes maximum. 3. Receive upper frequency tracking lower frequency 1650 kHz at minimum variable capacitor position. 4. Adjust TC5 so that output level becomes maximum. 5. Repeat the above step 1,2 through 3,4. 6. Receive lower frequency 600 kHz and adjust L6 so that output level becomes maximum. 7. Receive tracking upper frequency 1500 kHz and adjust TC6 so that output level becomes maximum. 8. Repeat the above step 6. through 7. so that output becomes maximum. 	<p data-bbox="1169 1323 1265 1346">Fig. 8-8</p>  <p data-bbox="1185 1637 1281 1659">Fig. 8-9</p>	<p data-bbox="1441 1352 1477 1375">L5</p> <p data-bbox="1430 1458 1489 1480">TC5</p> <p data-bbox="1441 1559 1477 1581">L6</p> <p data-bbox="1430 1637 1489 1659">TC6</p>
<p data-bbox="220 1702 368 1747">SW tracking adjustment</p>	<p data-bbox="427 1702 587 1724"><Conditions></p> <ol data-bbox="427 1731 946 1989" style="list-style-type: none"> 1. Radio band: SW position 2. Signal input: Dummy antenna <ul style="list-style-type: none"> Positive side to TP1 Negative side to TP2 3. Frequency of signal generator: <ul style="list-style-type: none"> 5.8 MHz (Tuning dial setting: low end) 18.6 MHz (Tuning dial setting: high end) 6.0 MHz (Tuning dial setting: 6.0 MHz) 18.0 MHz (Tuning dial setting: 18.0 MHz) 4. Measuring point: Headphone jack 		

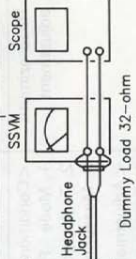
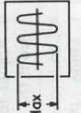
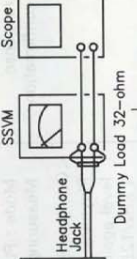
Item	Measuring Conditions and Main Adjustment	Standard Value	Adjust
FM tracking adjustment (PC-XT3 E/B) only	 <p>Fig. 8-10</p> <p><Adjustment></p> <ol style="list-style-type: none"> 1. Receive lower frequency 5.8 MHz at maximum variable capacitor position. 2. Adjust L7 so that output level becomes maximum. 3. Receive upper frequency tracking lower frequency 18.6 MHz at minimum variable capacitor position. 4. Adjust TC7 so that output level becomes maximum. 5. Repeat the above step 1,2 through 3,4. 6. Receive lower frequency 6.0 MHz and adjust L8 so that output level becomes maximum. 7. Receive tracking upper frequency 18.0 MHz and adjust TC8 so that output level becomes maximum. 8. Repeat the above step 6. through 7. so that output becomes maximum. 	<p>L7</p> <p>TC7</p> <p>L8</p> <p>TC8</p>  <p>Fig. 8-11</p>	
FM tracking adjustment (PC-XT3 E/B) only	 <p>Fig. 8-12</p> <p><Adjustment></p> <ol style="list-style-type: none"> 1. Receive lower frequency 87.5 MHz at maximum variable capacitor position. 2. Adjust L1 so that output level becomes maximum. 3. Receive upper frequency 109 MHz at minimum variable capacitor position. 4. Adjust TC1 so that output level becomes maximum. 5. Adjust the above adjust (L1 & TC1) repeatedly so that the tuner can be received above frequency range (band width). 6. Receive tracking lower frequency 90 MHz and adjust L2 so that output level becomes maximum. 7. Receive tracking upper frequency 106 MHz and adjust TC2 so that output level becomes maximum. 8. Adjust the above adjust (L2 & TC2) repeatedly so that the tuner can be obtained the best sensitivity. 	<p>L1</p> <p>TC1</p> <p>L2</p> <p>TC2</p>	

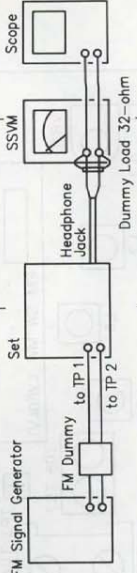
Item	Measuring Conditions and Main Adjustment	Standard Value	Adjust
FM tracking adjustment (PC-XT3 G) only	 <p>Fig. 8-13</p> <p><Conditions></p> <ol style="list-style-type: none"> 1. Radio band: FM 2. Signal input: 75 Ω unbalance Positive side to TP1 Negative side to TP2 3. Frequency of signal generator: 87.5 MHz (Tuning dial setting: low end) 108.3 MHz (Tuning dial setting: high end) 90 MHz (Tuning dial setting: 90 MHz) 106 MHz (Tuning dial setting: 106 MHz) 4. Measuring point: Headphone jack <p><Adjustment></p> <ol style="list-style-type: none"> 1. Receive lower frequency 87.5 MHz at maximum variable capacitor position. 2. Adjust L1 so that output level becomes maximum. 3. Receive upper frequency 108.3 MHz at minimum variable capacitor position. 4. Adjust TC1 and TC11 so that output level becomes maximum. 5. Adjust the above adjust (L1 & TC1 and TC11) repeatedly so that the tuner can be received above frequency range (band width). 6. Receive tracking lower frequency 90 MHz and adjust L2 so that output level becomes maximum. 7. Receive tracking upper frequency 106 MHz and adjust TC2 so that output level becomes maximum. 8. Adjust the above adjust (L2 & TC2) repeatedly so that the tuner can be obtained the best sensitivity. 	<p>L1</p> <p>TC1, TC11</p> <p>L2</p> <p>TC2</p>	
FM MPX confirmation	<p><Conditions></p> <ol style="list-style-type: none"> 1. Radio band: FM position 2. Signal input: 75 Ω unbalance Positive side to TP1 Negative side to TP2 3. Frequency of signal generator: 98 MHz 4. Output level of signal generator: 60 dBμV 5. Measuring point: Positive side to TP8 Negative side to TP7 <p><Confirmation></p> <ol style="list-style-type: none"> 1. Modulation off connect counter probe to TP8 and TP7. 2. Adjust VR1 to obtain 19±0.1 kHz. 	<p>19±0.1 kHz</p> <p>VR1</p>	

■ Location of Adjustment (Tuner Section)

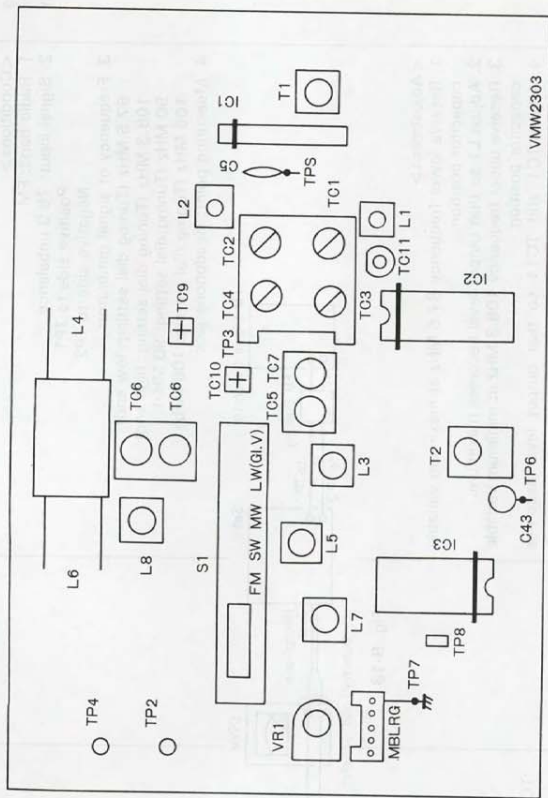

Fig. 8-14

(Amplifier Section)

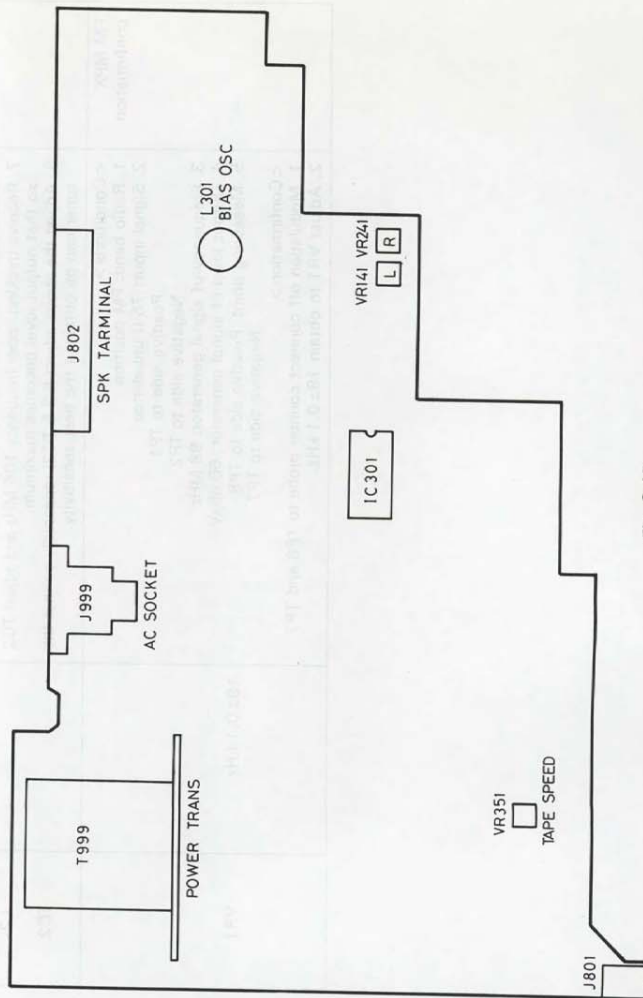

Fig. 8-15

■ Main Adjustment: Mechanism and Amplifier Sections

Item	Measuring Conditions and Main Adjustment	Standard Value	Adjust								
Head azimuth adjustment	<p><Conditions></p> <ol style="list-style-type: none"> Mode : PLAY Test tape : VTT702 (8 kHz) Measuring point : Speaker terminal <p><Adjustment></p> <ol style="list-style-type: none"> Connect an electronic voltmeter to the speaker terminal. Play the test tape VTT702. Adjust the head azimuth with screw (A) (Fig. 8-11) until the reading of the electronic voltmeter becomes -2 dB from the peak. Adjust to peak between FWD/REV within -4 dB from the peak. 	<p>Fig. 8-16</p> <p>-2 dB from the peak</p> <p>Left side screw of A or B mechanism</p>									
Tape speed and wow-flutter adjustment	<p><Conditions></p> <ol style="list-style-type: none"> Mode : PLAY, Normal speed Test tape : VTT712 at tape end measuring point : Speaker terminal <p><Confirmation></p> <ol style="list-style-type: none"> Connect a wow-flutter meter to speaker terminal. Play the test tape VTT712 at tape end. Adjust the VR351 so that is obtained within 2950~3050 Hz at normal speed. Check to see if reading of the meter is less than 0.35% (JIS RMS). 	<p>Normal Speed : 2950 ~ 3050 Hz</p> <p>High speed : 5100 ~ 5900 Hz</p> <p>Wow-flutter : less than 0.35% (JIS RMS)</p> <p>VR351</p>									
Playback frequency response confirmation	<p><Conditions></p> <p>Test tape : VTT736</p> <p>Mode : PLAY</p> <p>Measuring point : Speaker terminal</p> <p><Confirmation></p> <p>Playback the test tape VTT736 difference level against 1 kHz.</p> <p>1 kHz/125 Hz : 1 ± 3 dB</p> <p>1 kHz/8 kHz : -1 ± 3 dB</p>	<p>1 kHz/125 Hz : 1 ± 3 dB</p> <p>1 kHz/8 kHz : -1 ± 3 dB</p>									
Recording and playback frequency response confirmation	<p><Conditions></p> <ol style="list-style-type: none"> Test tape : UR(TS8) Signal input : MIC Recording level : Reference -20 dB <p>Measuring point : Speaker terminal</p> <p><Confirmation></p> <ol style="list-style-type: none"> Reference signal -20 dB to be applied to MIC. Difference level between 125 Hz and 8 kHz against 1 kHz to be checked. 1 kHz/125 Hz : -1 ± 4 dB 1 kHz/8 kHz : 0 ± 4 dB 	<p>1 kHz/125 Hz : -1 ± 4 dB</p> <p>1 kHz/8 kHz : 0 ± 4 dB</p>									
Bias frequency adjustment	<p><Conditions></p> <ol style="list-style-type: none"> Measuring point : Speaker terminal Adjust L341 so that becomes is obtain standard value. 	<table border="1"> <thead> <tr> <th>Beat Cut Switch</th> <th>Bias frequency</th> </tr> </thead> <tbody> <tr> <td>1 (Normal)</td> <td>72 kHz\pm3 kHz</td> </tr> <tr> <td>2</td> <td>70 kHz\pm3 kHz</td> </tr> <tr> <td>3</td> <td>68 kHz\pm3 kHz</td> </tr> </tbody> </table> <p>L341</p>	Beat Cut Switch	Bias frequency	1 (Normal)	72 kHz \pm 3 kHz	2	70 kHz \pm 3 kHz	3	68 kHz \pm 3 kHz	
Beat Cut Switch	Bias frequency										
1 (Normal)	72 kHz \pm 3 kHz										
2	70 kHz \pm 3 kHz										
3	68 kHz \pm 3 kHz										

Item	Measuring Conditions and Main Adjustments	Standard Value	Adjust
Rec./playback sensitivity adjustment	<p>[Conditions]</p> <p>1. Mode: REC, PLAY Mechanism B</p> <p>2. Test tape: UR (TS8)</p> <p>3. Measuring point: output ... Speaker terminal</p> <p>[Adjustment]</p> <p>Adjust the VR141 (L ch) and VR241 (R ch) so that 1 kHz -6 dBs against monitor level becomes 0 ± 1 dB.</p>	0±1 dB	L ch : VR141 R ch : VR241

■ Adjust of CD Player Section

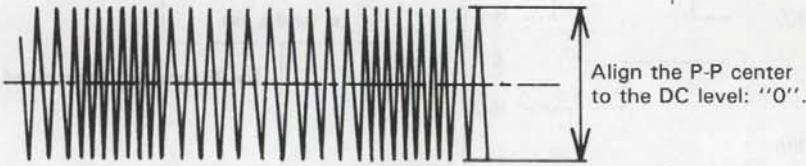
Items	Devices Used	Adjustment Method	Adjusting Position
Adjustment of tracking offset	Normal disk oscilloscope	<ol style="list-style-type: none"> 1. Connect the oscilloscope between TP502 (VREF) and TP503 (TE). 2. Connect the terminal ① and ④ of FW501 and apply 10 V to the terminal ② of FW501. 3. Replay (Regenerate) the normal disk. 4. Connect TP504 and TP502 (for shorting). 5. Adjust (the tracking offset waveform with) VR501 so that the DC level of tracking error signal (waveform of oscilloscope) becomes zero. <p style="text-align: center;">Waveform of tracking offset</p>  <p style="text-align: right;">Align the P-P center to the DC level: "0".</p> <p>Notes</p> <ol style="list-style-type: none"> 1. Adjust VR501 so that the waveform becomes vertically symmetrical with reference to the zero level. 2. The oscilloscope input should be coupled to DC. 	VR501

■ Layout Diagram of Adjusting Positions

(CD Control P.C. board View)

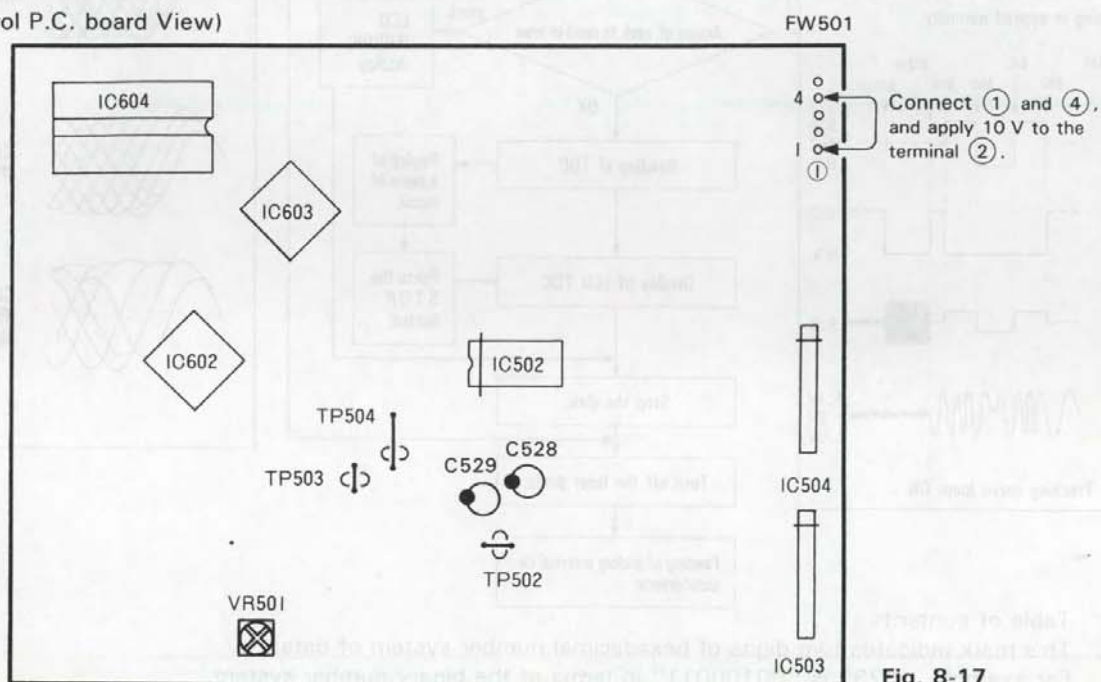
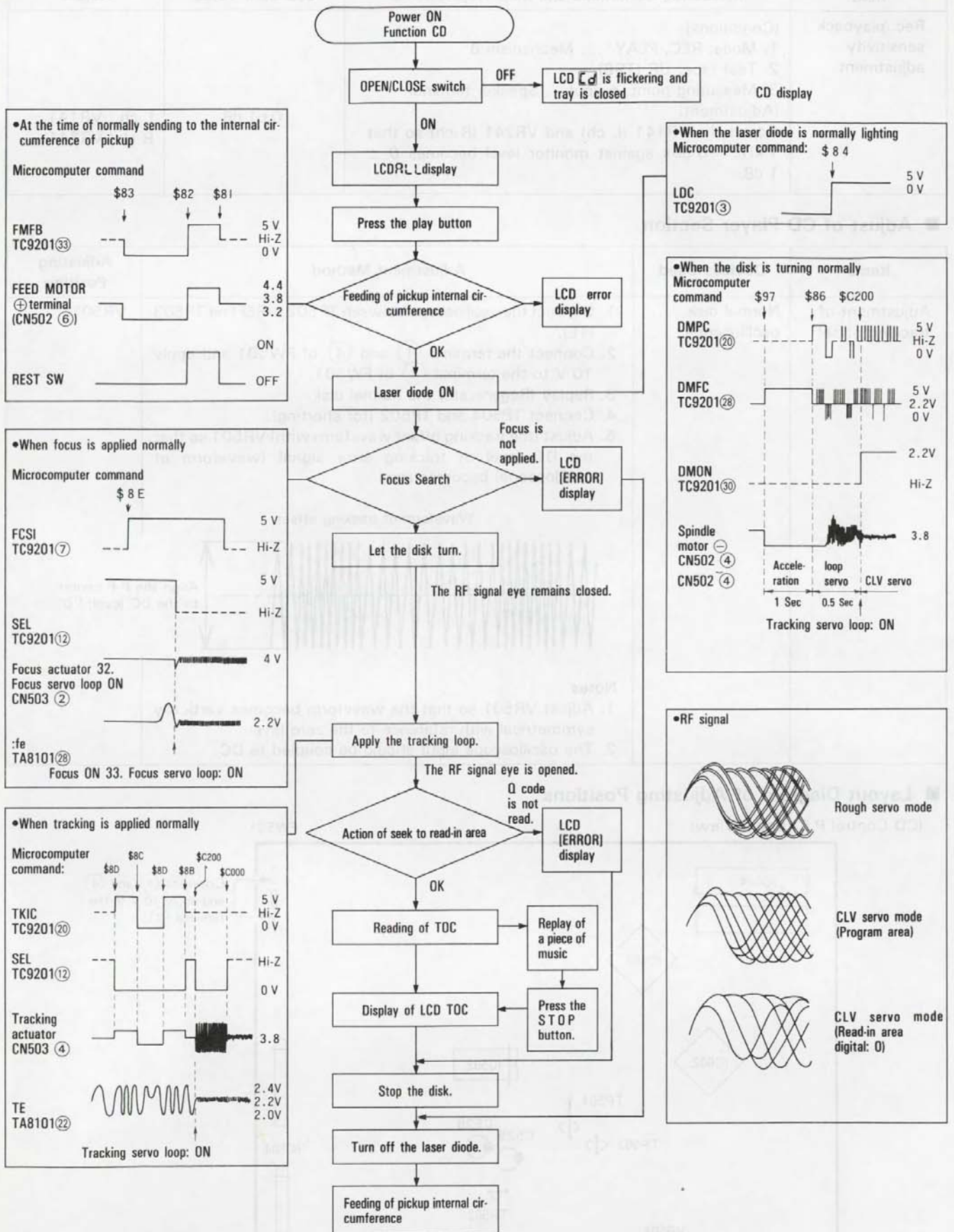

Fig. 8-17

■ General Flow Diagram until Reading of TOC (Table of Contents)



TOC : Table of contents

\$ mark : This mark indicates two digits of hexadecimal number system of data.

For example, "\$23" is "00100011" in terms of the binary number system.

■ General Section

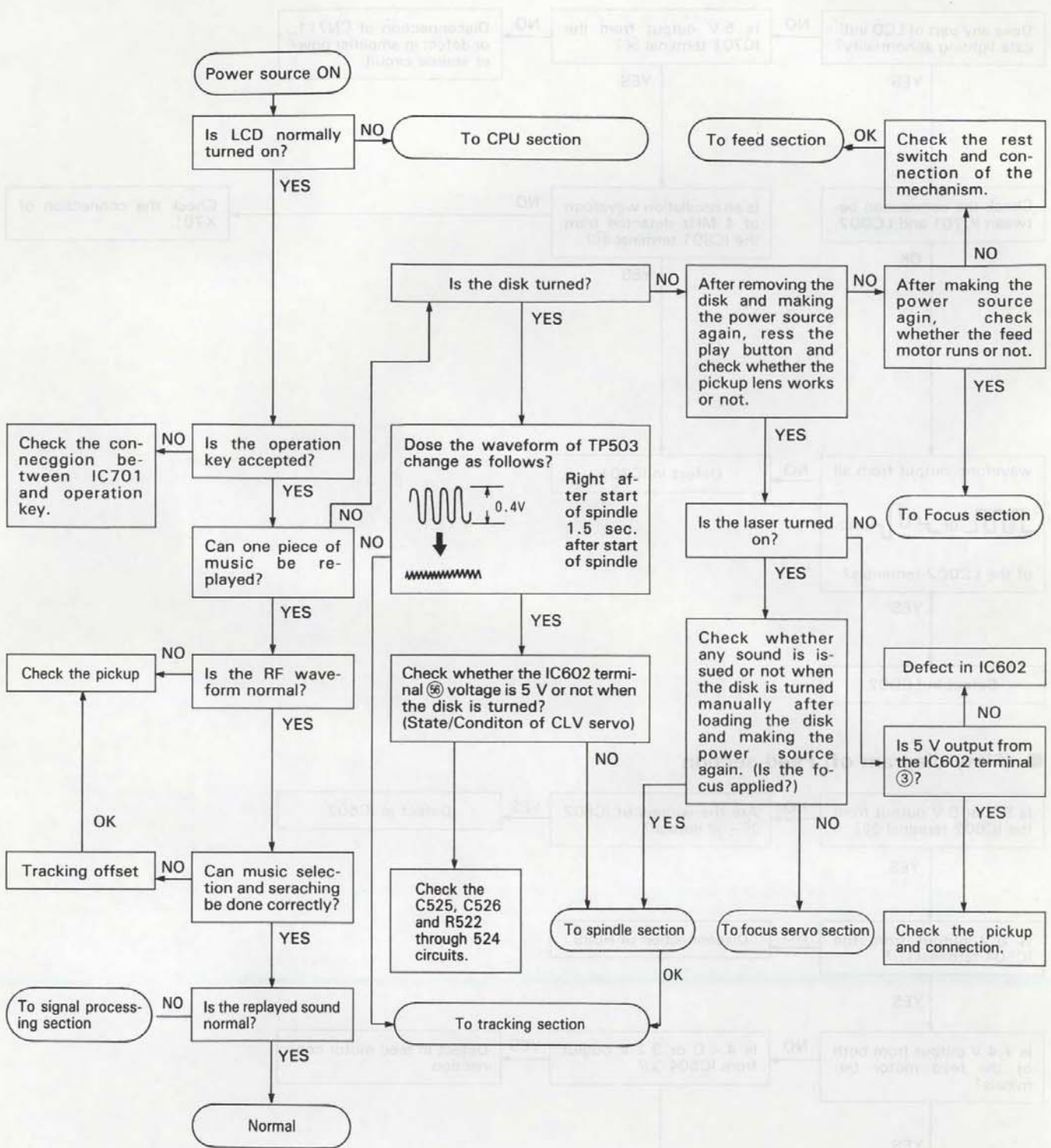

RF : Radio frequency
 CLV : Constant linear velocity
 CPU : Central processing unit

■ CPU (Flow diagram of) CPU section

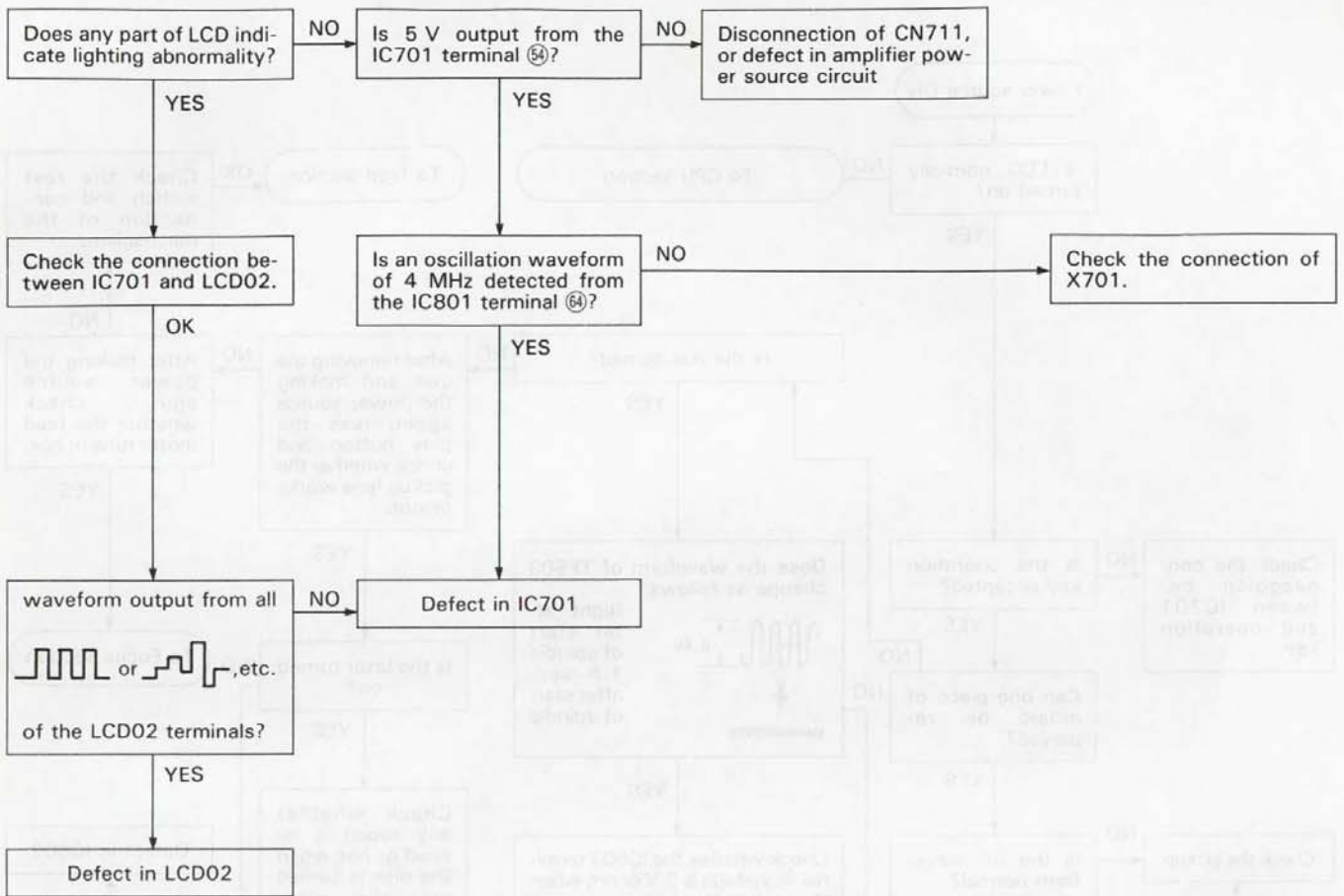

■ (Flow diagram of) Feed section

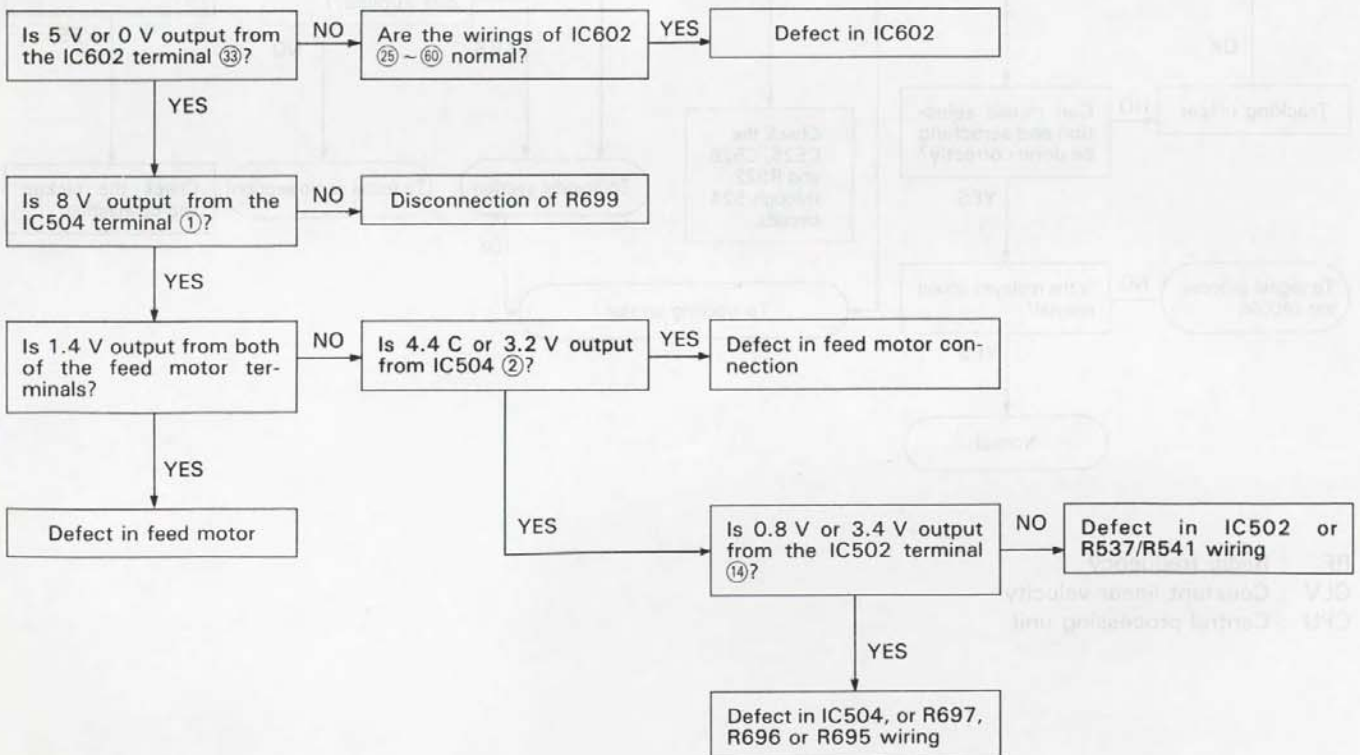

■ (Flow diagram of) focus servo section

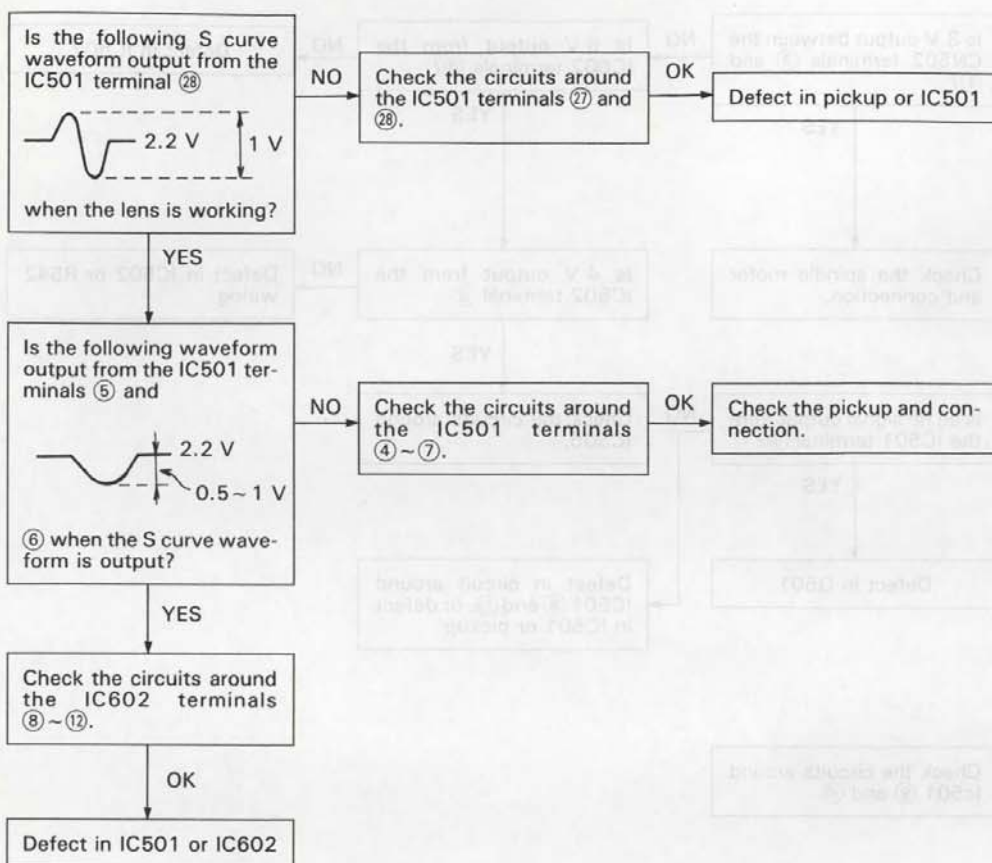

■ (Flow Diagram of) Focus drive section

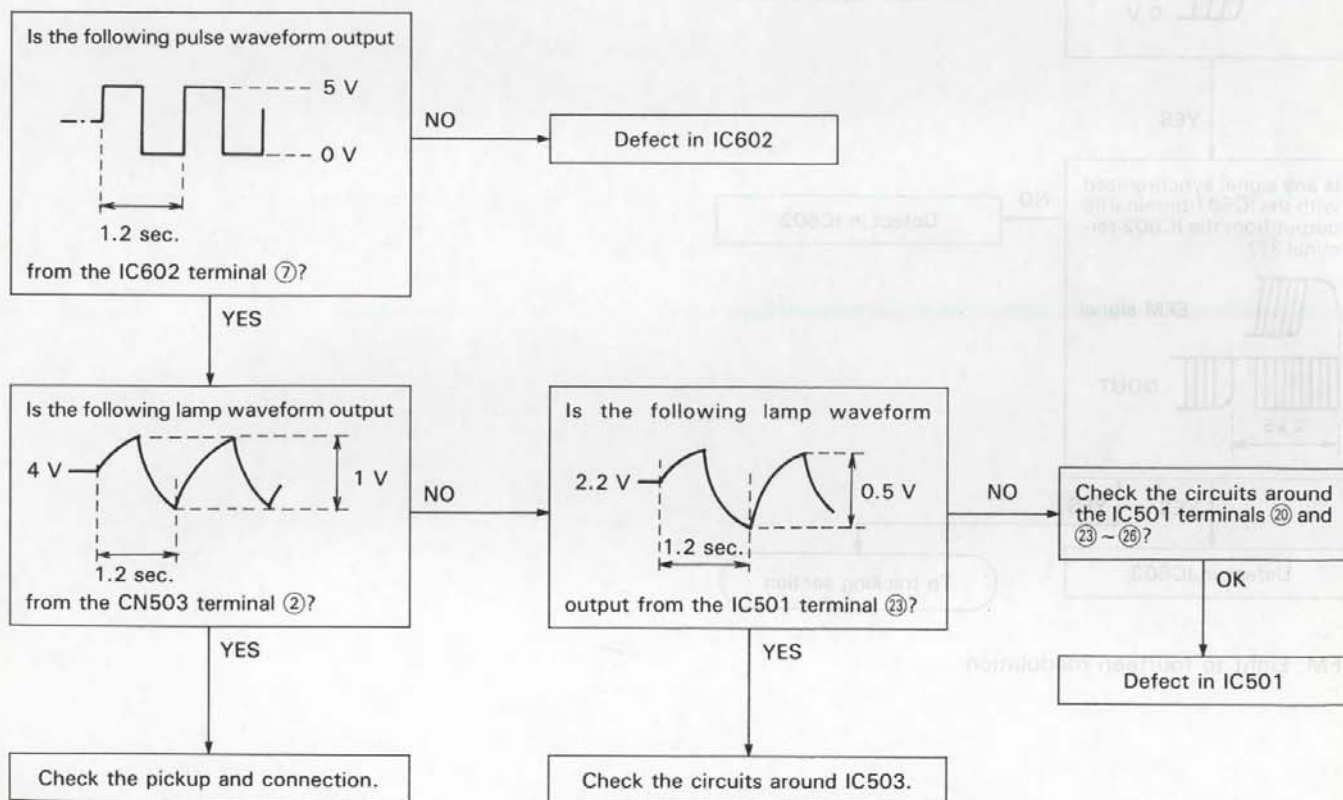

■ Spindle section

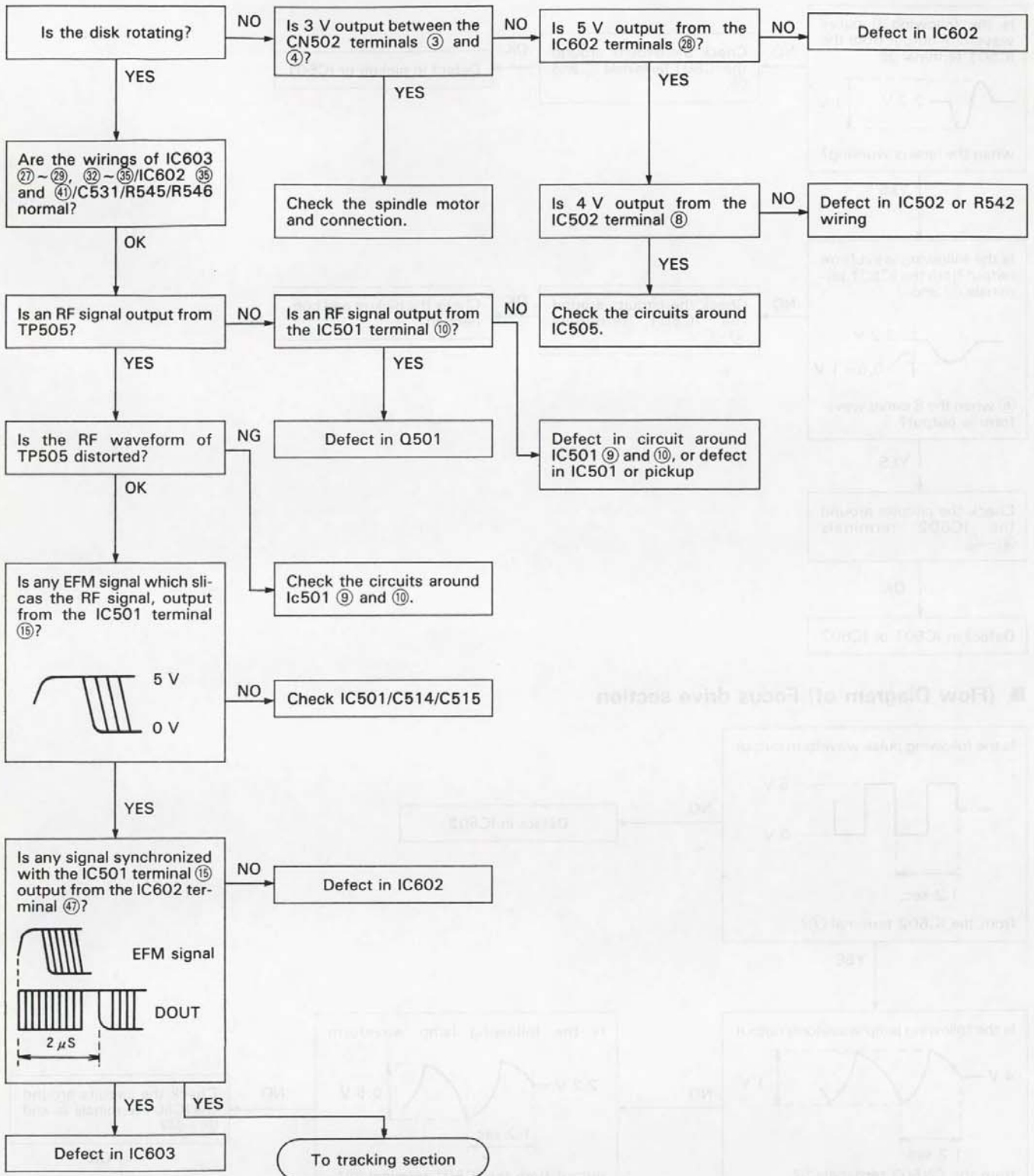

EFM: Eight to fourteen modulation

Tracking section

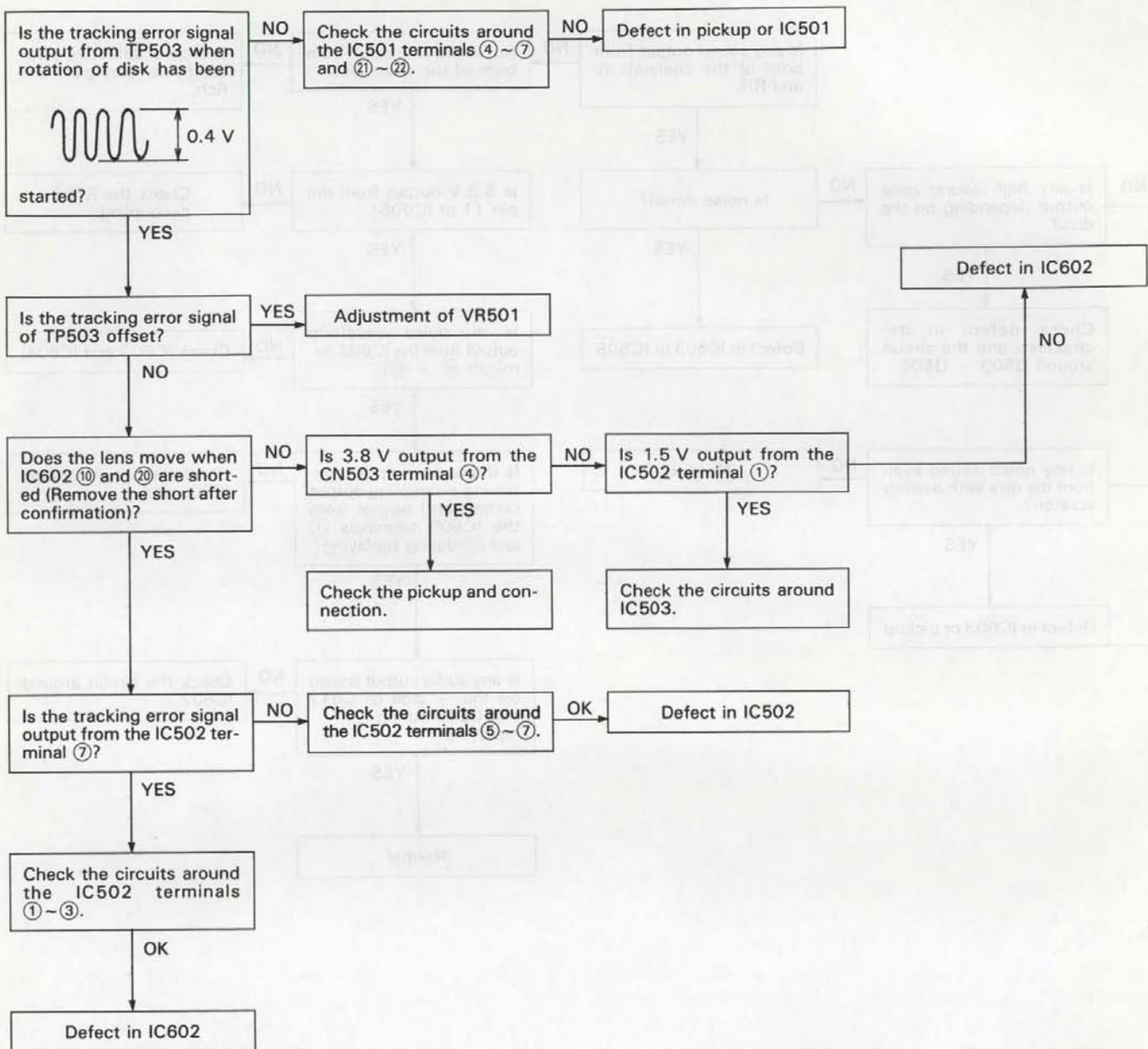

■ Signal processing section

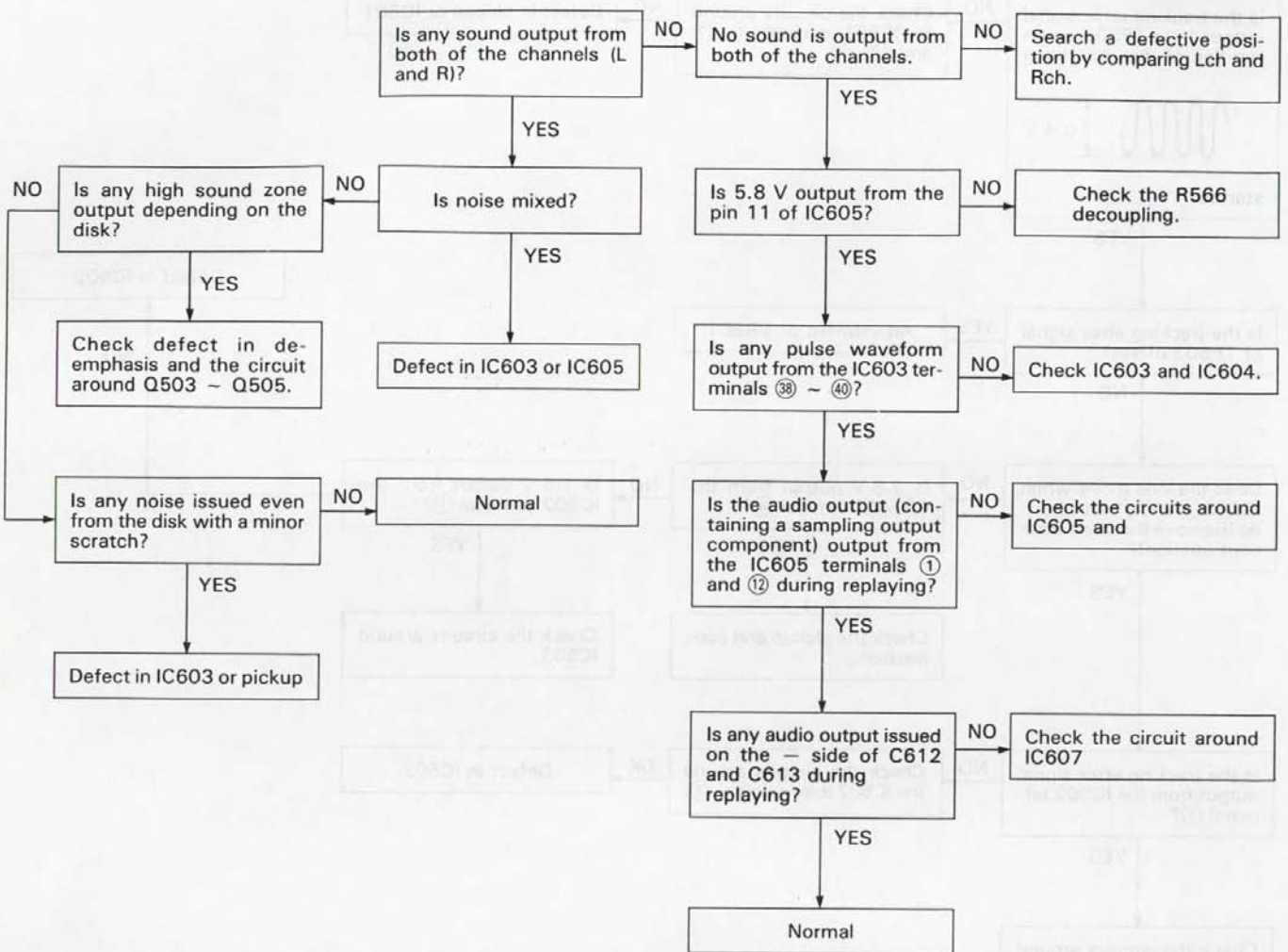

9 Block Diagram

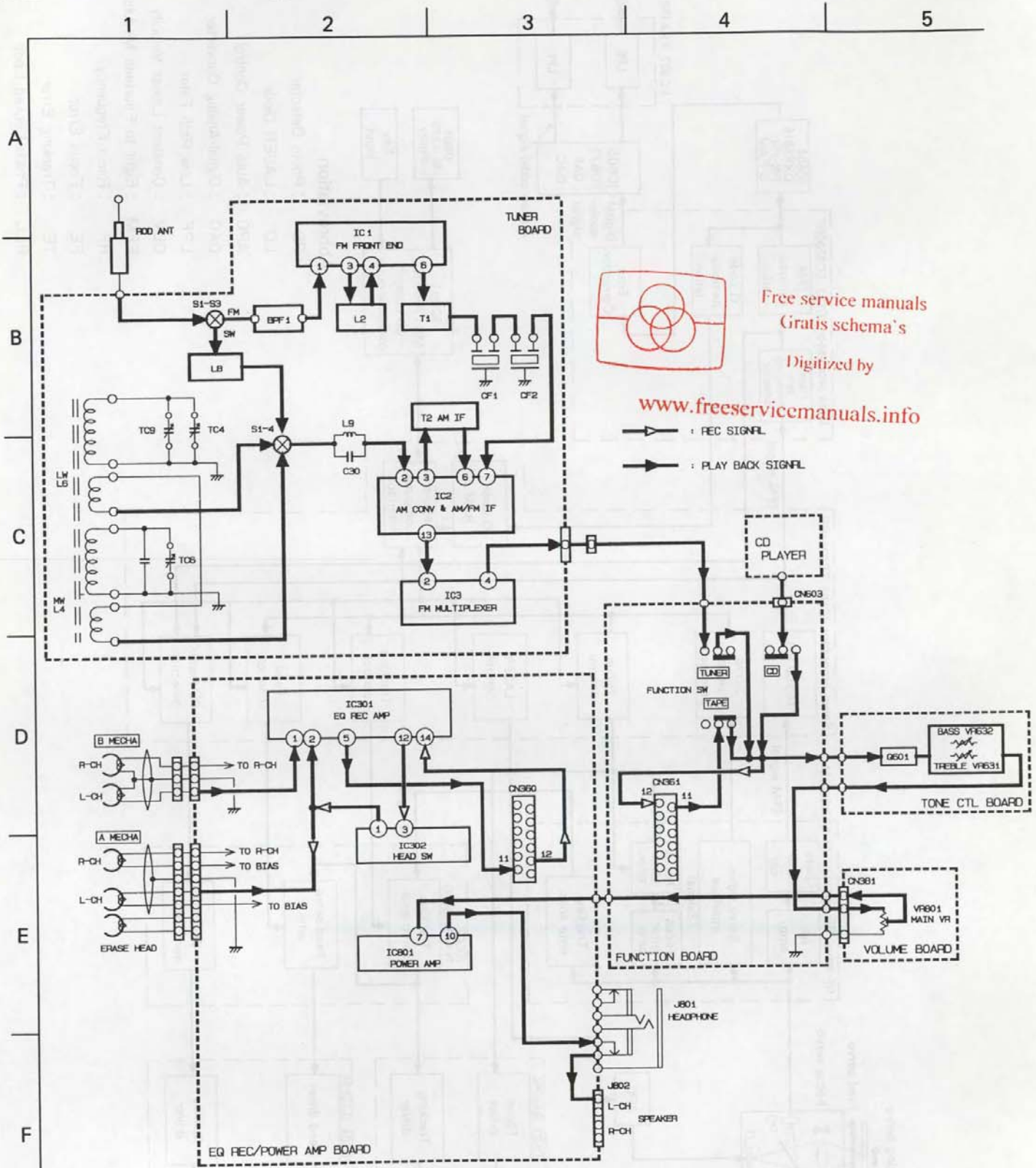

Free service manuals
Gratis schema's

Digitized by

www.freeservicemanuals.info

Fig. 9-1

■ CD Player Sections

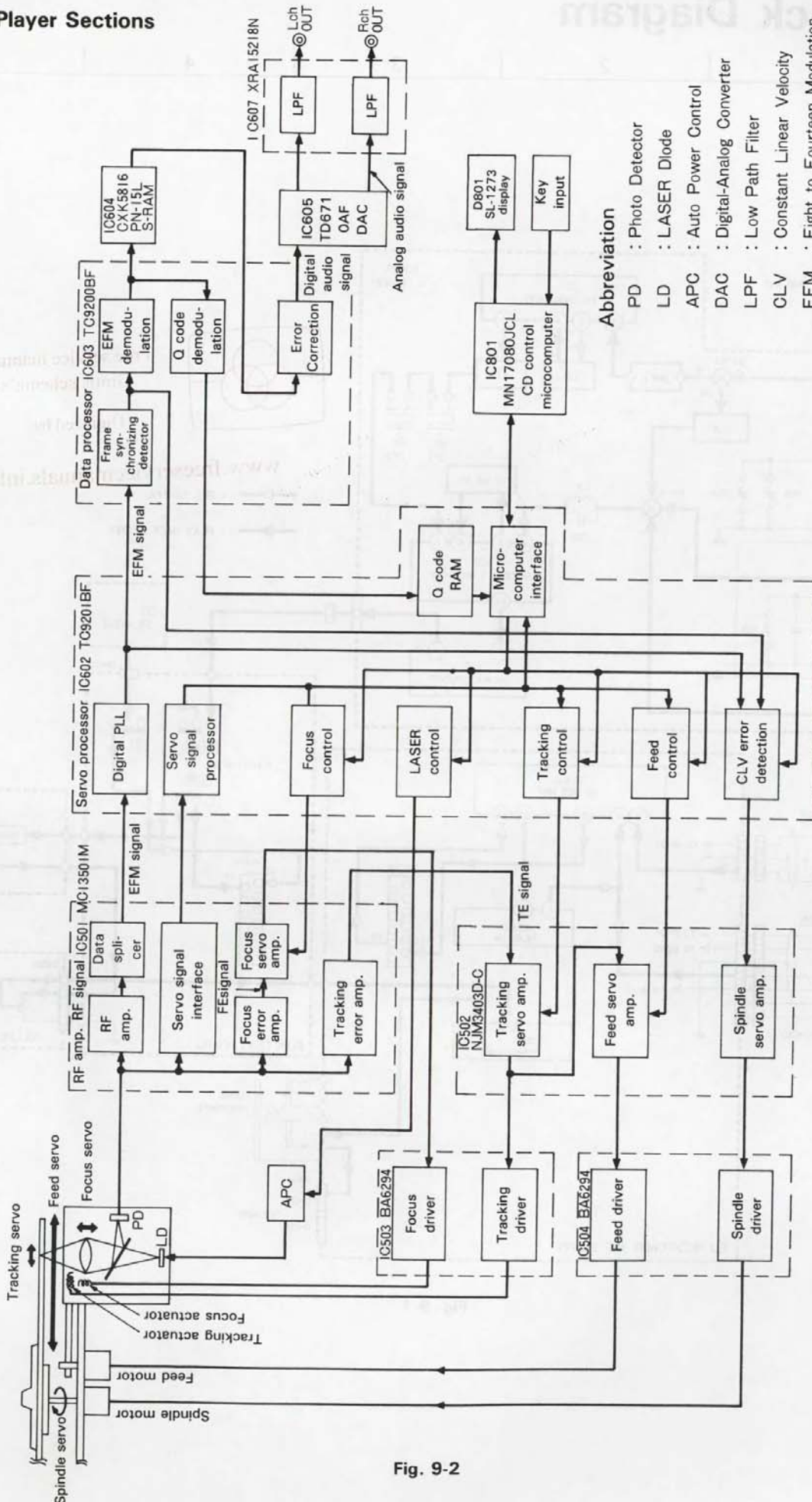

Abbreviation

- PD : Photo Detector
- LD : LASER Diode
- APC : Auto Power Control
- DAC : Digital-Analog Converter
- LPF : Low Path Filter
- CLV : Constant Linear Velocity
- EFM : Eight to Fourteen Modulation
- RF : Radio Frequency
- FE : Focus Error
- TE : Tracking Error
- PLL : Phase Locked Loop

Fig. 9-2

10 Wiring Connections

1 2 3 4 5 6 7 8 9 10

• CD Player Section

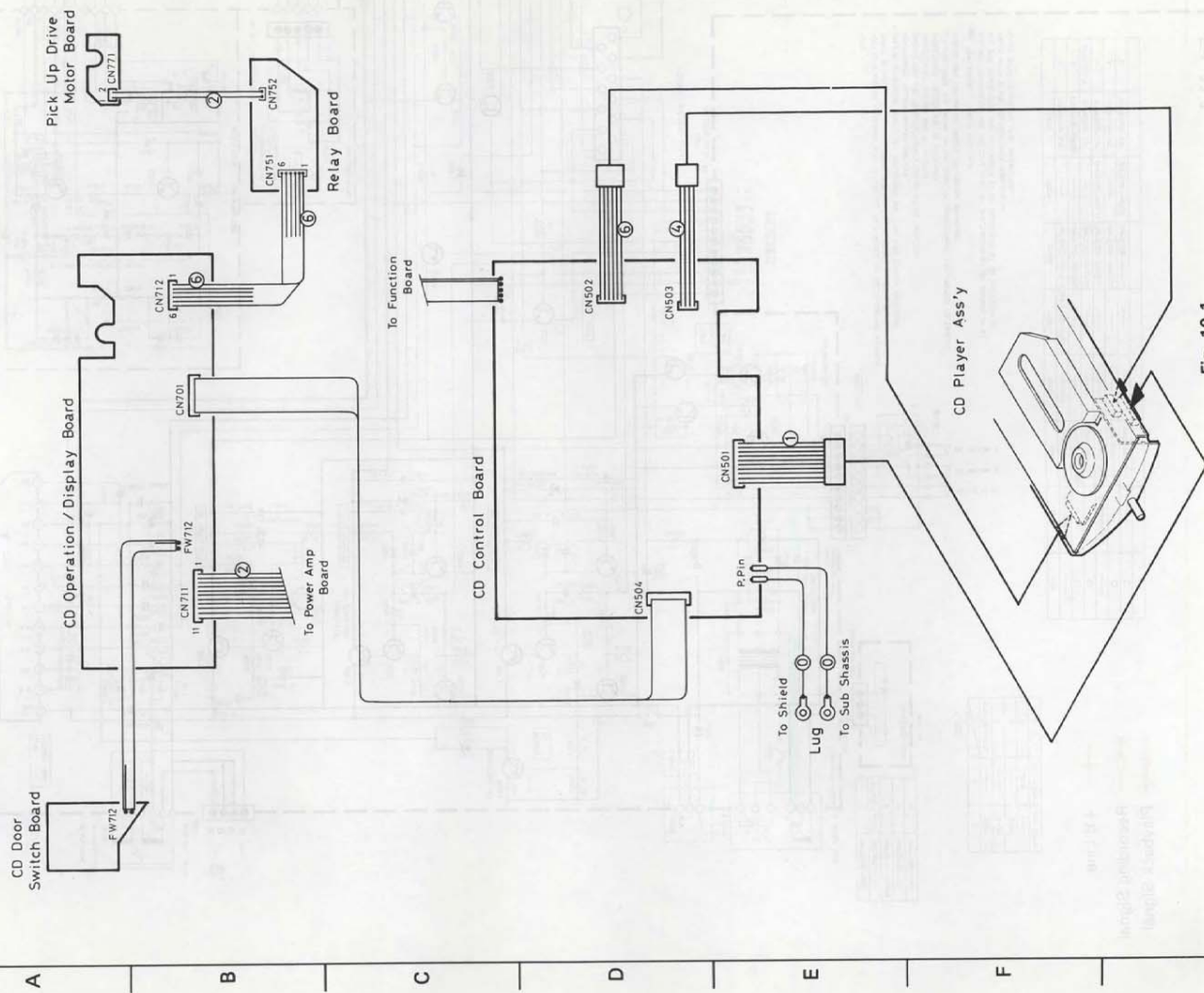

Fig. 10-1

• Amplifier Section

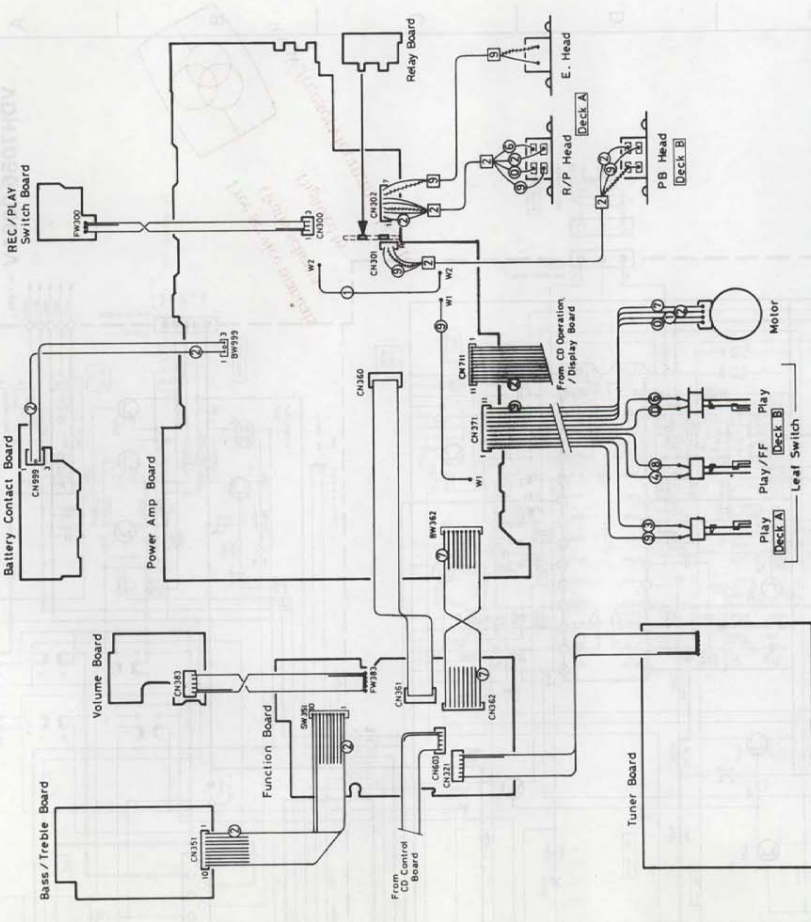

Fig. 10-2

Color codes are shown below.

- 1 Brown
- 2 Red
- 3 Orange
- 4 Yellow
- 5 Green
- 6 Blue
- 7 Violet
- 8 Gray
- 9 White
- 0 Black
- D Pink
- C Light Blue

This Parts List can be found on the page 52. (Block No. 01111111)

■ Amplifier/Power Supply P.C. Board: Drawing No. VMW1260A

■ Relay P.C. Board: Drawing No. VMW1260G

■ Volume P.C. Board: Drawing No. VMW1260D

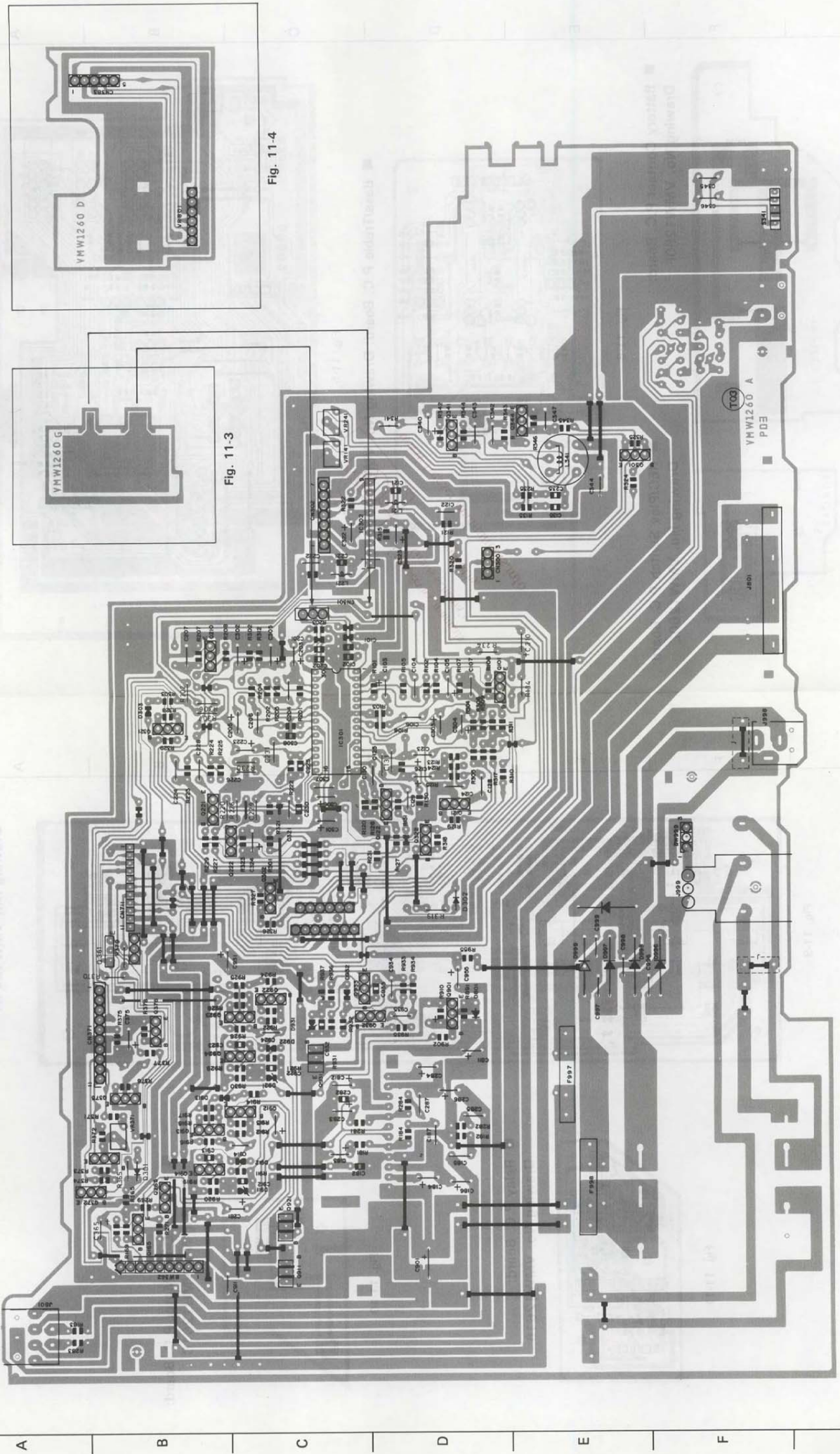

Fig. 11-3

Fig. 11-4

Fig. 11-2

This Parts List can be found on the page 57. (Block No. 04)

1 2 3 4 5

CD Operation/Display P.C. Board: Drawing No. VMW1261A

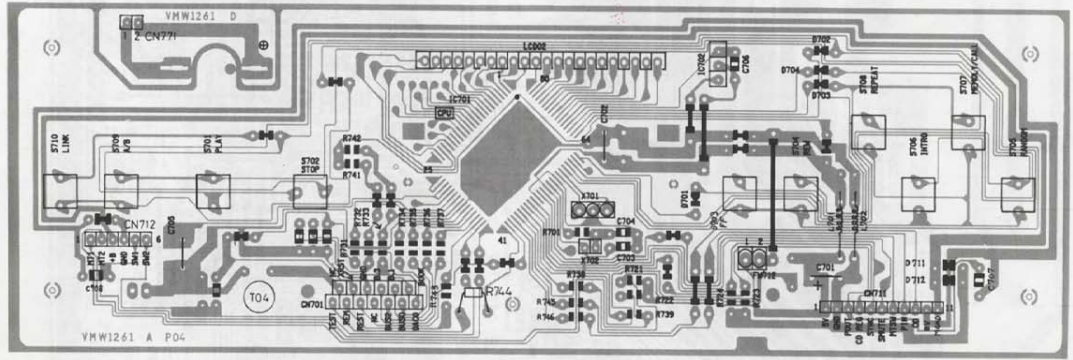

Fig. 11-9

Pick Up Drive Motor P.C. Board: Drawing No. VMH1261C

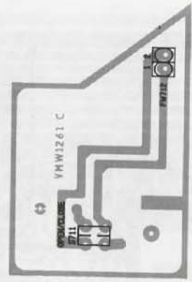

Fig. 11-10

Relay P.C. Board: Drawing No. VMW1261B

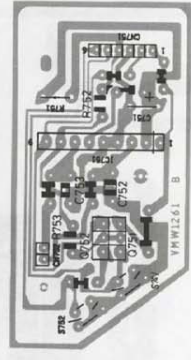

Fig. 11-11

This Parts List can be found on the page 52. (Block No. 01)

1 2 3 4 5

Function P.C. Board: Drawing No. VMW1260B

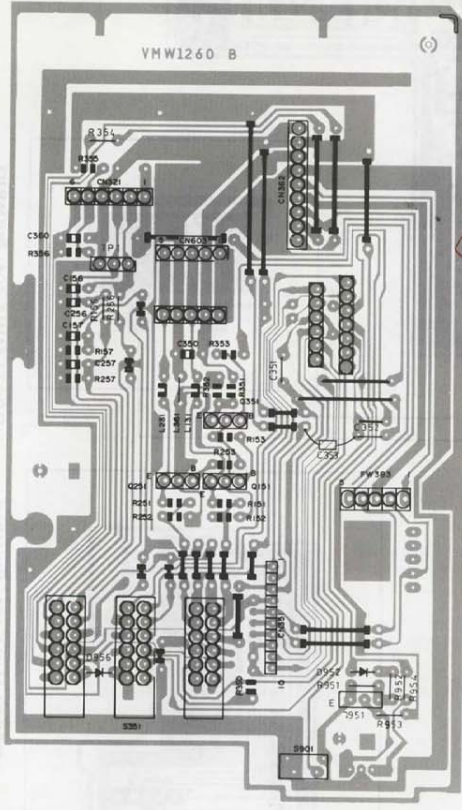

Fig. 11-5

Bass/Treble P.C. Board: Drawing No. VMW1260C

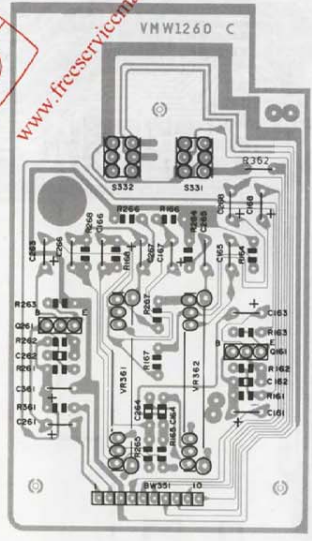

Fig. 11-6

Battery Contact P.C. Board: Drawing No. VMW1260F

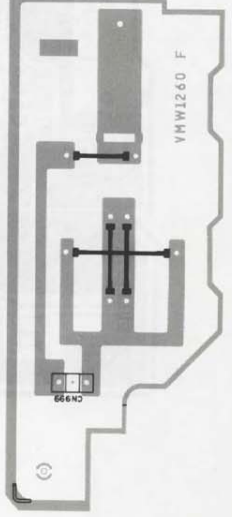

Fig. 11-7

REC/Play Switch P.C. Board: Drawing No. VMW1260E

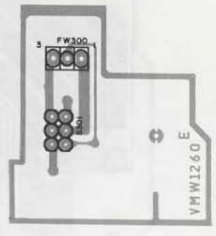

Fig. 11-8

1 2 3 4 5 6 7 8 9 10

SYSTEM-CPU/CD Operation Display Circuit:
Drawing No. VDH7056-006SW

LC002

VL1087-001

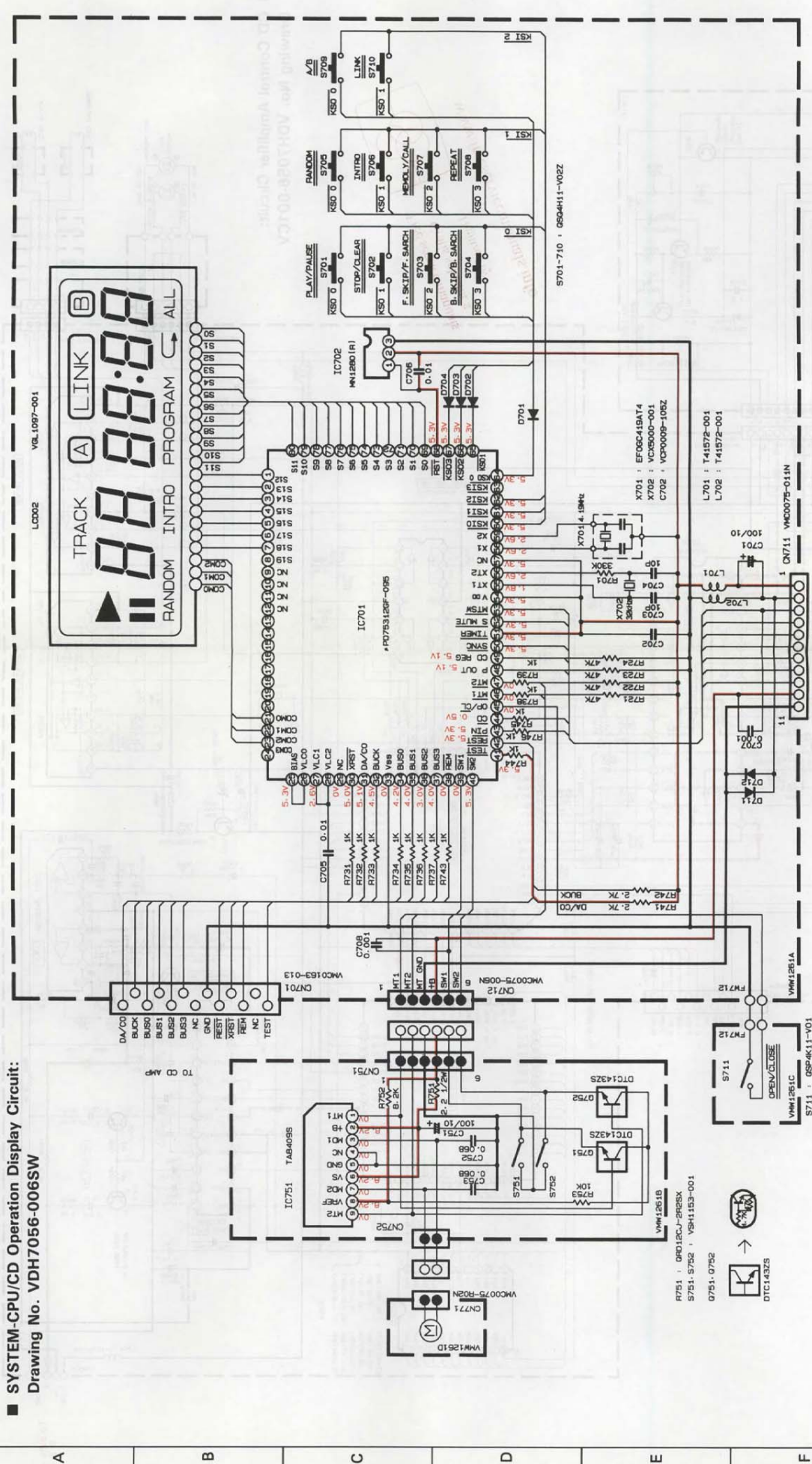

NOTES

- VOLTAGES ARE DC-MEASURED WITH A DIGITAL VOLT METER IN (Ω) (A) PLAYBACK.
CONDITION — CD MODE
- UNLESS OTHERWISE SPECIFIED, ALL RESISTORS ARE 1/8W ±5% CARBON RESISTOR.
ALL RESISTANCE VALUES ARE IN Ω(M)G.
ALL CAPACITORS ARE CERAMIC CAPACITOR OR MULAR CAPACITOR.
ALL CAPACITANCE VALUES ARE IN μF(P)F).
ALL INDUCTANCE VALUES ARE IN μH(M)H).
ALL E-CAPACITORS ARE SHOWN IN THE FORM OF CAPACITANCE (μF)/RATED VOLTAGE (V).
ALL DIODES ARE M1165 OR H55104 OR 1SS254.

Fig. 11-12

1 2 3 4 5 6 7 8 9 10

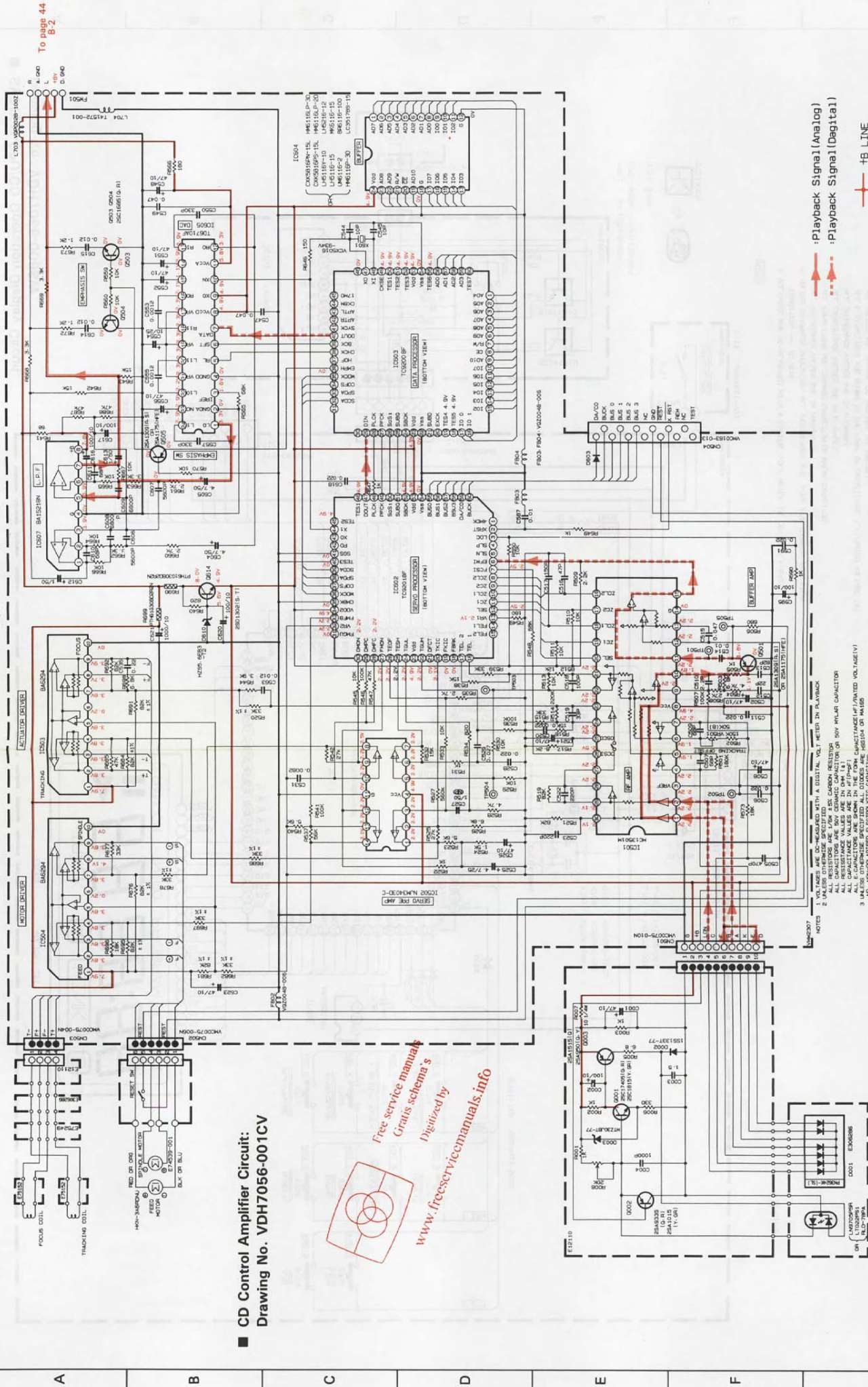

To page 44 B-2

CD Control Amplifier Circuit: Drawing No. VDH7056-001CV



Free service manual
 Gratis schema's
 Digitized by
www.freeservicemanuals.info

Playback Signal (Analog)
 Playback Signal (Digital)
 +B LINE

Fig. 11-13 (No. 1837) 48

NOTES
 1 VOLTAGES ARE TO BE MEASURED WITH A DIGITAL VOLT METER IN PLAYBACK MODE.
 2 ALL RESISTORS ARE 1/8W 5% CARBON RESISTOR UNLESS OTHERWISE SPECIFIED.
 3 ALL CAPACITORS ARE 50V UNLESS OTHERWISE SPECIFIED.
 4 ALL DIMENSIONS ARE IN MILLIMETERS UNLESS OTHERWISE SPECIFIED.
 5 ALL DIMENSIONS ARE IN MILLIMETERS UNLESS OTHERWISE SPECIFIED.
 6 ALL DIMENSIONS ARE IN MILLIMETERS UNLESS OTHERWISE SPECIFIED.
 7 ALL DIMENSIONS ARE IN MILLIMETERS UNLESS OTHERWISE SPECIFIED.
 8 ALL DIMENSIONS ARE IN MILLIMETERS UNLESS OTHERWISE SPECIFIED.
 9 ALL DIMENSIONS ARE IN MILLIMETERS UNLESS OTHERWISE SPECIFIED.
 10 ALL DIMENSIONS ARE IN MILLIMETERS UNLESS OTHERWISE SPECIFIED.

* This Parts List can be found on the page 56. (Block No. 03)

03

Free service manuals
Gratis schema's

1 2 3 4 5

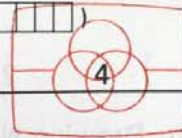

Digitized by

■ CD Control P.C. Board: Drawing No. VMW2307A

www.freeservicemanuals.info

A
B
C
D
E
F

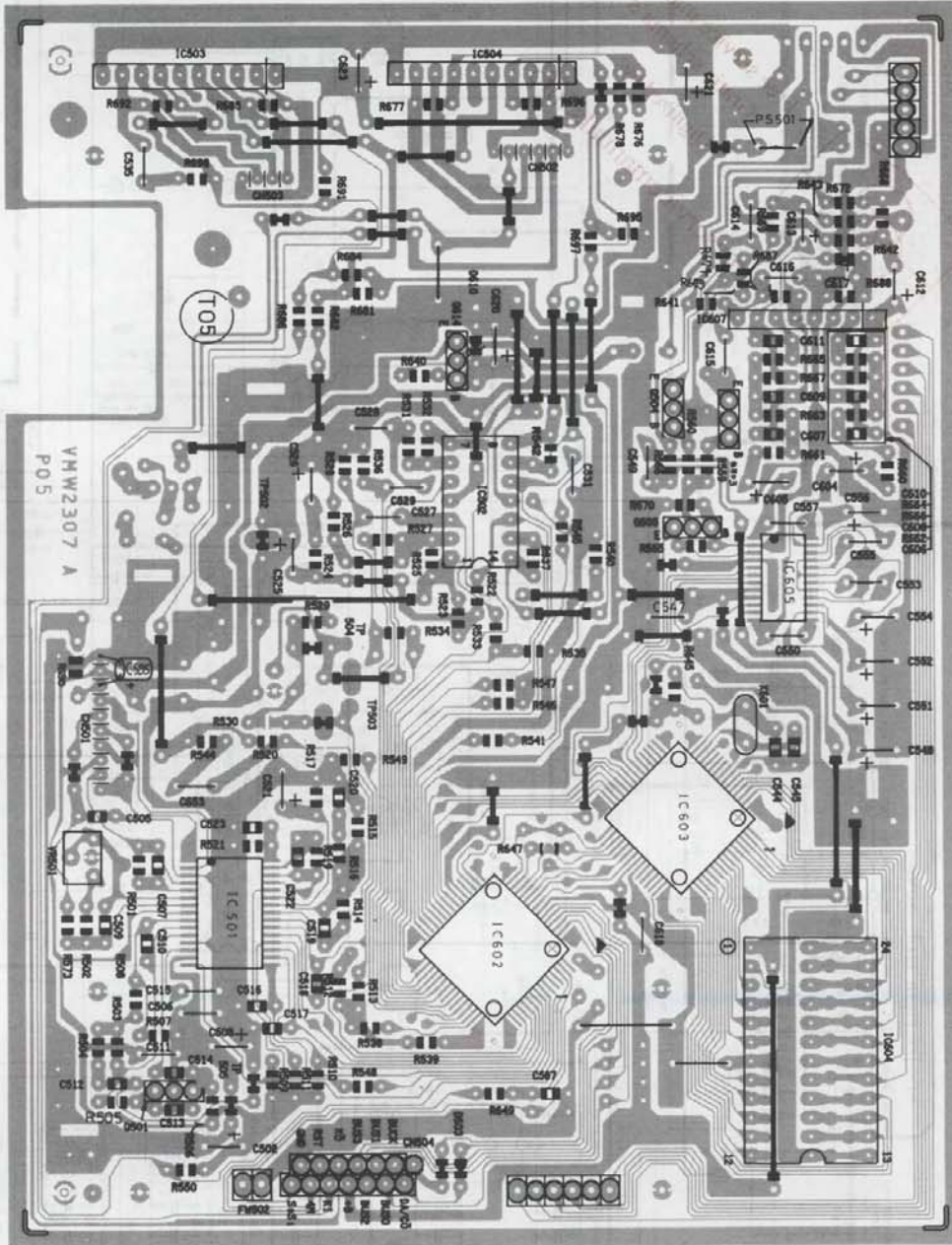

Fig. 11-14

■ Tuner Circuit: Drawing No. VDH7054-002TW

A

B

C

D

E

F

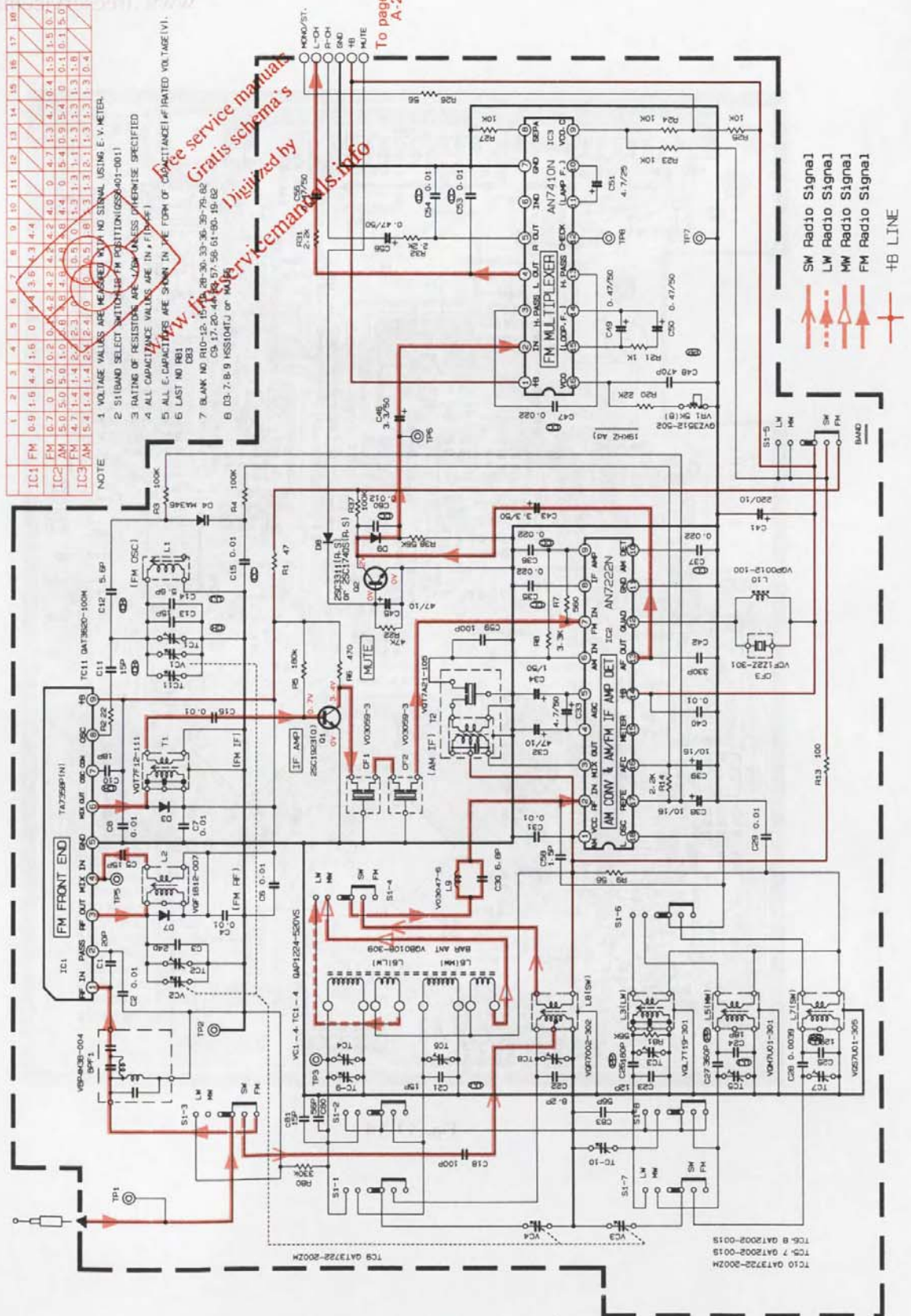

Fig. 11-15

* This Parts List can be found on the page 55. (Block No.)

	1	2	3	4	5
	■ Tuner P.C. Board: Drawing No. VMW2301				
A					
B					
C					
D					
E					
F					

Fig. 11-16

12 Electrical Parts List

■ Power Amplifier P.C. Board: Drawing No. VMW1260
BLOCK NO. 01

△	REF.	PARTS NO.	PARTS NAME
	C 101	QCBB1HK-681Y	C CAPACITOR
	C 102	QCBB1HK-561Y	C CAPACITOR
	C 103	QETC1AM-336ZN	E CAPACITOR
	C 104	QFV41HJ-123	FILM CAPACITOR
	C 105	QETC1HM-335ZN	E CAPACITOR
	C 106	QCC11EM-223	C CAPACITOR
	C 107	QCS11HJ-221	C CAPACITOR
	C 121	QCBB1HK-561Y	C CAPACITOR
	C 122	QCY41HK-102	C CAPACITOR
	C 123	QETC1HM-335ZN	E CAPACITOR
	C 124	QFV71HJ-153ZM	FILM CAPACITOR
	C 125	QCS11HJ-560	C. CAPACITOR
	C 126	QETC1AM-226ZN	E CAPACITOR
	C 128	QFV71HJ-153ZM	FILM CAPACITOR
	C 129	QETC1HM-475ZN	E CAPACITOR
	C 130	QCBB1HK-391Y	C. CAPACITOR
	C 131	QFV71HJ-273ZM	TF. CAPACITOR
	C 135	QCBB1HK-221Y	C CAPACITOR
	C 156	QCXB1CM-152Y	C CAPACITOR
	C 157	QCBB1HK-561Y	C CAPACITOR
	C 161	QETC1HM-335ZN	E CAPACITOR
	C 162	QCBB1HK-221Y	C CAPACITOR
	C 163	QETC1HM-684ZN	E. CAPACITOR
	C 164	QCXB1CM-472Y	C. CAPACITOR
	C 165	QFV71HJ-393ZM	FILM CAPACITOR
	C 166	QFV71HJ-563ZM	TF. CAPACITOR
	C 167	QETC1HM-224ZN	E CAPACITOR
	C 168	QETC1HM-105ZN	E CAPACITOR
	C 181	QER41HM-224	E CAPACITOR
	C 182	QCBB1HK-221Y	C CAPACITOR
	C 183	QETC1AM-336ZN	E CAPACITOR
	C 184	QETC1AM-476ZN	E CAPACITOR
	C 185	QCC11EM-104	C CAPACITOR
	C 186	QETC1AM-108ZN	E CAPACITOR
	C 187	QCC31EM-393ZV	C CAPACITOR
	C 201	QCBB1HK-681Y	C CAPACITOR
	C 202	QCBB1HK-561Y	C CAPACITOR
	C 203	QETC1AM-336ZN	E CAPACITOR
	C 204	QFV41HJ-123	FILM CAPACITOR
	C 205	QETC1HM-335ZN	E CAPACITOR
	C 206	QCC11EM-223	C CAPACITOR
	C 207	QCS11HJ-221	C CAPACITOR
	C 221	QCBB1HK-561Y	C CAPACITOR
	C 222	QCY41HK-102	C CAPACITOR
	C 223	QETC1HM-335ZN	E CAPACITOR
	C 224	QFV71HJ-153ZM	FILM CAPACITOR
	C 225	QCS11HJ-560	C. CAPACITOR
	C 226	QETC1AM-226ZN	E CAPACITOR
	C 228	QFV71HJ-153ZM	FILM CAPACITOR
	C 229	QETC1HM-475ZN	E CAPACITOR
	C 230	QCBB1HK-391Y	C. CAPACITOR
	C 231	QFV71HJ-273ZM	TF. CAPACITOR
	C 235	QCBB1HK-221Y	C CAPACITOR
	C 256	QCXB1CM-152Y	C CAPACITOR
	C 257	QCBB1HK-561Y	C CAPACITOR
	C 261	QETC1HM-335ZN	E CAPACITOR
	C 262	QCBB1HK-221Y	C CAPACITOR
	C 263	QETC1HM-684ZN	E. CAPACITOR
	C 264	QCXB1CM-472Y	C. CAPACITOR
	C 265	QFV71HJ-393ZM	FILM CAPACITOR
	C 266	QFV71HJ-563ZM	TF. CAPACITOR
	C 267	QETC1HM-224ZN	E CAPACITOR
	C 268	QETC1HM-105ZN	E CAPACITOR
	C 281	QER41HM-224	E CAPACITOR

△	REF.	PARTS NO.	PARTS NAME
	C 282	QCBB1HK-221Y	C CAPACITOR
	C 283	QETC1AM-336ZN	E CAPACITOR
	C 284	QETC1AM-476ZN	E CAPACITOR
	C 285	QCC11EM-104	C CAPACITOR
	C 286	QETC1AM-108ZN	E CAPACITOR
	C 287	QCC31EM-393ZV	C CAPACITOR
	C 301	QETC1AM-227ZN	E CAPACITOR
	C 302	QETC1EM-475ZN	E. CAPACITOR
	C 303	QETC1HM-475ZN	E CAPACITOR
	C 304	QETC1CM-106ZN	E CAPACITOR
	C 305	QETC1AM-226ZN	E CAPACITOR
	C 306	QETC1HM-475ZN	E CAPACITOR
	C 307	QCBB1HK-221Y	C CAPACITOR
	C 308	QCBB1HK-221Y	C CAPACITOR
	C 310	QETC1CM-106ZN	E CAPACITOR
	C 321	QETC1CM-106ZN	E CAPACITOR
	C 322	QETC1AM-226ZN	E CAPACITOR
	C 323	QETC1HM-475ZN	E CAPACITOR
	C 324	QETC1AM-226ZN	E CAPACITOR
	C 340	QETC1CM-106ZN	E CAPACITOR
	C 342	QCY41HK-682	C CAPACITOR
	C 343	QCC31EM-153ZV	C. CAPACITOR
	C 344	QFV41HJ-333	TF CAPACITOR
	C 345	QCY41HK-182	C CAPACITOR
	C 346	QFN41HJ-103	M CAPACITOR
	C 347	QETC1CM-106ZN	E CAPACITOR
	C 350	QCVB1CM-103Y	C CAPACITOR
	C 351	QETC1EM-475ZN	E. CAPACITOR
	C 352	QCS11HJ-151	C CAPACITOR
	C 353	QCBB1HK-102Y	C CAPACITOR
	C 360	QCBB1HK-221Y	C CAPACITOR
	C 361	QETC1AM-107ZN	E CAPACITOR
	C 365	QER41EM-475	E CAPACITOR
	C 375	QETA1AM-227N	E CAPACITOR
	C 811	QETB1EM-227N	E. CAPACITOR
	C 812	QETC1AM-227ZN	E CAPACITOR
△	C 901	QETB1EM-478	E. CAPACITOR
	C 911	QETC1AM-477ZN	E CAPACITOR
	C 912	QCVB1CM-103Y	C CAPACITOR
	C 913	QCBB1HK-102Y	C CAPACITOR
	C 914	QCC11EM-683	C CAPACITOR
	C 921	QETB1AM-476	E. CAPACITOR
	C 922	QCVB1CM-103Y	C CAPACITOR
	C 923	QCBB1HK-102Y	C CAPACITOR
	C 924	QCC11EM-683	C CAPACITOR
	C 931	QETC1AM-107ZN	E CAPACITOR
	C 932	QCVB1CM-103Y	C CAPACITOR
	C 933	QCBB1HK-102Y	C CAPACITOR
	C 934	QCC11EM-683	C CAPACITOR
	C 935	QCC11EM-683	C CAPACITOR
	C 955	QETC1HM-106ZN	E. CAPACITOR
	C 996	QFV41HJ-104	TF CAPACITOR
	C 997	QFV41HJ-104	TF CAPACITOR
	C 998	QFV41HJ-104	TF CAPACITOR
	C 999	QFV41HJ-104	TF CAPACITOR
	CNTP1	VMC0040-003	CONNECTOR
	CN300	EMV7112-003	SOCKET
	CN301	VMC0040-003	CONNECTOR
	CN302	QMV5012-007	CONNECTOR
	CN321	EMV7112-006	SOCKET
	CN351	VMC0075-010N	CONNECTOR
	CN360	VMC0236-012Z	CONNECTOR
	CN361	VMC0236-012Z	CONNECTOR
	CN362	VMC0040-009	CONNECTOR
	CN371	VMC0040-010	CONNECTOR

△	REF.	PARTS NO.	PARTS NAME
	CN383	EMV7112-005	SOCKET
	CN603	EMV7112-005	SOCKET
	CN999	VMC0041-003	CONNECTOR
	D 301	1SS254T	SI DIODE
	D 302	1SS254T	SI DIODE
	D 303	1SS254T	SI DIODE
	D 801	1SR35	SI DIODE
	D 911	MA4075(M)	DIODE
	D 912	1SS254	SI DIODE
	D 913	1SS254	SI DIODE
	D 921	MA4075(M)	DIODE
	D 922	1SS254T	SI DIODE
	D 931	MA4047N(H)	Z DIODE
	D 932	1SS254T	SI DIODE
	D 952	1SS254T	SI DIODE
	D 956	MA700	ZENER DIODE
△	D 995	1N5401M	DIODE
△	D 996	1N5401M	DIODE
△	D 997	1N5401M	DIODE
△	D 998	1N5401M	DIODE
△	D 999	1N5401M	DIODE
	IC301	TA2010N	IC
	IC302	UPC1330HA	IC
△	IC801	TAB207K	IC
	J 801	VMJ4024-001	JACK
	J 802	EMB90YV-401A	SPK. TERMINAL
	J 998	QMA431B-V01	DC JACK
	J 999	QMC0263-004	AC SOCKET
	L 121	VQP0001-103ZS	INDUCTOR
	L 131	VQP025K-330Y	INDUCTOR
	L 221	VQP0001-103ZS	INDUCTOR
	L 231	VQP025K-330Y	INDUCTOR
	L 341	VQH1009-026	OSC COIL
	L 361	VQZ0048-007	INDUCTOR
	L 371	VQP0028-100Z	INDUCTOR
	Q 101	2SC1740S(RS)	TRANSISTOR
	Q 121	2SC1740S(RS)	TRANSISTOR
	Q 122	2SC1740S(RS)	TRANSISTOR
	Q 151	2SC1740S(RS)	TRANSISTOR
	Q 161	2SC945L(P,Q)	TRANSISTOR
	Q 165	2SC1740S(RS)	TRANSISTOR
	Q 201	2SC1740S(RS)	TRANSISTOR
	Q 221	2SC1740S(RS)	TRANSISTOR
	Q 222	2SC1740S(RS)	TRANSISTOR
	Q 251	2SC1740S(RS)	TRANSISTOR
	Q 261	2SC945L(P,Q)	TRANSISTOR
	Q 265	2SC1740S(RS)	TRANSISTOR
	Q 301	2SA933S(RS)	TRANSISTOR
	Q 302	2SC1740S(RS)	TRANSISTOR
	Q 321	2SC1740S(RS)	TRANSISTOR
	Q 322	2SA933S(RS)	TRANSISTOR
	Q 341	2SC1740S(RS)	TRANSISTOR
	Q 344	2SD1302(S,T)	TRANSISTOR
	Q 351	2SA933S(RS)	TRANSISTOR
	Q 361	UN411F	TRANSISTOR
	Q 362	UN4211	TRANSISTOR
	Q 371	2SC1740S(RS)	TRANSISTOR
	Q 372	2SC1740S(RS)	TRANSISTOR
	Q 375	2SA952(L,K)	TRANSISTOR
	Q 376	2SC1740S(RS)	TRANSISTOR
△	Q 901	2SA952(L,K)	TRANSISTOR
	Q 911	2SB772(Q,P)	TRANSISTOR
	Q 912	2SC1740S(RS)	TRANSISTOR
	Q 913	2SC1740S(RS)	TRANSISTOR
	Q 914	2SC1740S(RS)	TRANSISTOR

△	REF.	PARTS NO.	PARTS NAME
△	Q 921	2SB941(P)	TRANSISTOR
	Q 922	2SC1740S(RS)	TRANSISTOR
	Q 923	2SC1740S(RS)	TRANSISTOR
	Q 924	2SC1740S(RS)	TRANSISTOR
△	Q 931	2SB772(Q,P)	TRANSISTOR
	Q 932	2SC1740S(RS)	TRANSISTOR
	Q 933	2SC1740S(RS)	TRANSISTOR
	Q 951	2SC1740S(RS)	TRANSISTOR
	R 101	QRD161J-224	CARBON RESISTOR
	R 102	QRD161J-123	C RESISTOR
	R 103	QRD161J-121	C RESISTOR
	R 104	QRD161J-472	CARBON RESISTOR
	R 105	QRD161J-153	C RESISTOR
	R 106	QRD161J-102	CARBON RESISTOR
	R 107	QRD161J-682	C RESISTOR
	R 108	QRD161J-472	CARBON RESISTOR
	R 120	QRD161J-222	CARBON RESISTOR
	R 121	QRD161J-223	CARBON RESISTOR
	R 122	QRD161J-683	CARBON RESISTOR
	R 123	QRD161J-561	C RESISTOR
	R 124	QRD161J-221	C RESISTOR
	R 125	QRD161J-561	C RESISTOR
	R 126	QRD161J-153	C RESISTOR
	R 127	QRD161J-273	C RESISTOR
	R 129	QRD161J-103	CARBON RESISTOR
	R 130	QRD161J-513	C RESISTOR
	R 131	QRD161J-103	CARBON RESISTOR
	R 134	QRD161J-222	CARBON RESISTOR
	R 135	QRD161J-562	C RESISTOR
	R 151	QRD161J-273	C RESISTOR
	R 152	QRD161J-332	CARBON RESISTOR
	R 153	QRD161J-103	CARBON RESISTOR
	R 156	QRD161J-222	CARBON RESISTOR
	R 157	QRD161J-103	CARBON RESISTOR
	R 161	QRD161J-824	C RESISTOR
	R 162	QRD161J-222	CARBON RESISTOR
	R 163	QRD161J-271	C RESISTOR
	R 164	QRD161J-681	C RESISTOR
	R 165	QRD161J-822	CARBON RESISTOR
	R 166	QRD161J-152	CARBON RESISTOR
	R 167	QRD161J-102	CARBON RESISTOR
	R 168	QRD161J-184	C RESISTOR
	R 169	QRD161J-471	CARBON RESISTOR
	R 171	QRD161J-222	CARBON RESISTOR
	R 181	QRD161J-151	CARBON RESISTOR
	R 182	QRD161J-2R2	CARBON RESISTOR
	R 183	QRD161J-151	CARBON RESISTOR
	R 184	QRD161J-333	CARBON RESISTOR
	R 201	QRD161J-224	CARBON RESISTOR
	R 202	QRD161J-123	C RESISTOR
	R 203	QRD161J-121	C RESISTOR
	R 204	QRD161J-472	CARBON RESISTOR
	R 205	QRD161J-153	C RESISTOR
	R 206	QRD161J-102	CARBON RESISTOR
	R 207	QRD161J-682	C RESISTOR
	R 208	QRD161J-472	CARBON RESISTOR
	R 220	QRD161J-222	CARBON RESISTOR
	R 221	QRD161J-223	CARBON RESISTOR
	R 222	QRD161J-683	CARBON RESISTOR
	R 223	QRD161J-561	C RESISTOR
	R 224	QRD161J-221	C RESISTOR
	R 225	QRD161J-561	C RESISTOR
	R 226	QRD161J-153	C RESISTOR
	R 227	QRD161J-273	C RESISTOR
	R 229	QRD161J-103	CARBON RESISTOR

△	REF.	PARTS NO.	PARTS NAME
	R 230	QRD161J-513	C RESISTOR
	R 231	QRD161J-103	CARBON RESISTOR
	R 234	QRD161J-222	CARBON RESISTOR
	R 235	QRD161J-562	C RESISTOR
	R 251	QRD161J-273	C RESISTOR
	R 252	QRD161J-332	CARBON RESISTOR
	R 253	QRD161J-103	CARBON RESISTOR
	R 256	QRD161J-222	CARBON RESISTOR
	R 257	QRD161J-103	CARBON RESISTOR
	R 261	QRD161J-824	C RESISTOR
	R 262	QRD161J-222	CARBON RESISTOR
	R 263	QRD161J-271	C RESISTOR
	R 264	QRD161J-681	C RESISTOR
	R 265	QRD161J-822	CARBON RESISTOR
	R 266	QRD161J-152	CARBON RESISTOR
	R 267	QRD161J-102	CARBON RESISTOR
	R 268	QRD161J-184	C RESISTOR
	R 269	QRD161J-471	CARBON RESISTOR
	R 271	QRD161J-222	CARBON RESISTOR
	R 281	QRD161J-151	CARBON RESISTOR
	R 282	QRD161J-2R2	CARBON RESISTOR
	R 283	QRD161J-151	CARBON RESISTOR
	R 284	QRD161J-333	CARBON RESISTOR
	R 301	QRD161J-101	CARBON RESISTOR
	R 302	QRD161J-273	C RESISTOR
	R 303	QRD161J-683	CARBON RESISTOR
	R 304	QRD161J-333	C RESISTOR
	R 305	QRD161J-473	CARBON RESISTOR
	R 306	QRD161J-223	CARBON RESISTOR
	R 307	QRD161J-333	C RESISTOR
	R 309	QRD161J-683	CARBON RESISTOR
	R 311	QRD161J-223	CARBON RESISTOR
	R 312	QRD161J-473	CARBON RESISTOR
	R 315	QRD161J-223	CARBON RESISTOR
	R 317	QRD161J-103	CARBON RESISTOR
	R 318	QRD161J-473	CARBON RESISTOR
	R 319	QRD161J-473	CARBON RESISTOR
	R 320	QRD161J-103	CARBON RESISTOR
	R 321	QRD161J-105	CARBON RESISTOR
	R 322	QRD161J-101	CARBON RESISTOR
	R 323	QRD161J-103	CARBON RESISTOR
	R 324	QRD161J-473	CARBON RESISTOR
	R 325	QRD161J-103	CARBON RESISTOR
	R 326	QRD161J-473	CARBON RESISTOR
	R 327	QRD161J-103	CARBON RESISTOR
	R 328	QRD161J-473	CARBON RESISTOR
	R 329	QRD161J-103	CARBON RESISTOR
	R 341	QRD161J-151	C RESISTOR
	R 342	QRD161J-3R3	C RESISTOR
	R 343	QRD161J-153	C RESISTOR
	R 344	QRD161J-101	CARBON RESISTOR
	R 345	QRD161J-472	CARBON RESISTOR
	R 346	QRD161J-103	CARBON RESISTOR
	R 350	QRD161J-273	C RESISTOR
	R 351	QRD161J-331	CARBON RESISTOR
	R 352	QRD161J-391	C RESISTOR
	R 353	QRD161J-103	CARBON RESISTOR
	R 354	QRD161J-121	C RESISTOR
	R 355	QRD141J-470S	CARBON RESISTOR
	R 356	QRD161J-103	CARBON RESISTOR
	R 361	QRD161J-101	CARBON RESISTOR
	R 362	QRD161J-472	CARBON RESISTOR
	R 365	QRD161J-103	CARBON RESISTOR
	R 366	QRD161J-272	C.RESISTOR
	R 370	QRD161J-273	C RESISTOR

△	REF.	PARTS NO.	PARTS NAME
	R 371	QRD161J-222	CARBON RESISTOR
	R 372	QRD161J-392	CARBON RESISTOR
	R 373	QRD161J-104	CARBON RESISTOR
	R 374	QRD161J-104	CARBON RESISTOR
	R 375	QRD161J-124	C RESISTOR
	R 376	QRD161J-103	CARBON RESISTOR
	R 377	QRD161J-471	CARBON RESISTOR
	R 378	QRD161J-103	CARBON RESISTOR
	R 379	QRD161J-103	CARBON RESISTOR
	R 891	QRD161J-220	CARBON RESISTOR
	R 901	QRD161J-272	C.RESISTOR
	R 902	QRD161J-272	C.RESISTOR
	R 911	QRD161J-472	CARBON RESISTOR
	R 912	QRD161J-331	CARBON RESISTOR
	R 913	QRD161J-564	C RESISTOR
	R 914	QRD161J-102	CARBON RESISTOR
	R 916	QRD161J-104	CARBON RESISTOR
	R 917	QRD161J-472	CARBON RESISTOR
	R 918	QRD161J-472	CARBON RESISTOR
	R 919	QRD161J-103	CARBON RESISTOR
	R 920	QRD161J-102	CARBON RESISTOR
	R 921	QRD161J-472	CARBON RESISTOR
	R 922	QRD161J-331	CARBON RESISTOR
	R 923	QRD161J-564	C RESISTOR
	R 924	QRD161J-271	C RESISTOR
	R 925	QRD161J-271	C RESISTOR
	R 926	QRD161J-104	CARBON RESISTOR
	R 927	QRD161J-472	CARBON RESISTOR
	R 928	QRD161J-472	CARBON RESISTOR
	R 929	QRD161J-103	CARBON RESISTOR
	R 930	QRD161J-102	CARBON RESISTOR
	R 931	QRD161J-562	C RESISTOR
	R 932	QRD161J-331	CARBON RESISTOR
	R 933	QRD161J-123	C RESISTOR
	R 934	QRD161J-224	CARBON RESISTOR
	R 935	QRD161J-224	CARBON RESISTOR
	R 936	QRD161J-103	CARBON RESISTOR
	R 937	QRD161J-562	C RESISTOR
	R 951	QRD161J-103	CARBON RESISTOR
	R 952	QRD161J-103	CARBON RESISTOR
	R 953	QRD161J-182	CARBON RESISTOR
	R 954	QRD161J-182	CARBON RESISTOR
	R 955	QRD161J-102	CARBON RESISTOR
	S 301	QST3101-V10	PUSH SWITCH
	S 331	QSP2256-005	PUSH SWITCH
	S 332	QSP2256-005	PUSH SWITCH
	S 341	QSS1301-101	SLIDE SWITCH
	S 351	QSTT331-V01	PUSH SW
	S 901	QSP0301-003M	TACT SWITCH
	VR141	QVPA603-503AZM	V RESISTOR
	VR241	QVPA603-503AZM	V RESISTOR
	VR361	QVXB1JA-V06	V RESISTOR
	VR362	QVXB1JA-V06	V RESISTOR
	VR371	QVPA603-202AZM	V RESISTOR
	VR801	VCV1001-124	V RESISTOR(A)

■ Tuner P.C. Board:

Drawing No. VMW2301

BLOCK NO. 02

△	REF.	PARTS NO.	PARTS NAME
	BPF 1	VBP4M3B-004	BP FILTER
	C 001	QCS11HJ-200	C CAPACITOR
	C 002	QCVB1CN-103Y	C CAPACITOR
	C 003	QCS11HJ-240	C CAPACITOR
	C 004	QCVB1CN-103Y	C CAPACITOR
	C 005	QCS11HJ-150	C CAPACITOR
	C 006	QCVB1CN-103Y	C CAPACITOR
	C 007	QCVB1CN-103Y	C CAPACITOR
	C 008	QCVB1CN-103Y	C CAPACITOR
	C 010	QCT30CH-180Y	C. CAPACITOR
	C 011	QCT30CH-150Y	C CAPACITOR
	C 012	QCT30CH-5R6Y	C CAPACITOR
	C 013	QCT30CH-150Y	C CAPACITOR
	C 014	QCT30UJ-5R6Y	C CAPACITOR
	C 015	QCC11EM-103	C CAPACITOR
	C 016	QCF11HP-103	C CAPACITOR
	C 018	QCB1HK-101Y	C CAPACITOR
	C 021	QCT05UJ-150	C. CAPACITOR
	C 022	QCSB1HK-8R2Y	C CAPACITOR
	C 023	QCS11HJ-120	C CAPACITOR
	C 024	QCT05UJ-180	C. CAPACITOR
	C 025	QCT30UJ-120Y	C. CAPACITOR
	C 026	QFP31HJ-181ZM	PP. CAPACITOR
	C 027	QFP31HJ-361ZM	PP. CAPACITOR
	C 028	QCY41HK-392	C CAPACITOR
	C 029	QCVB1CN-103Y	C CAPACITOR
	C 030	QCSB1HK-6R8Y	C. CAPACITOR
	C 031	QCVB1CN-103Y	C CAPACITOR
	C 032	QETC1AM-476ZM	E CAPACITOR
	C 033	QETC1HM-475ZM	E CAPACITOR
	C 034	QETC1HM-105ZM	E CAPACITOR
	C 035	QCC11EM-223	C CAPACITOR
	C 036	QCC11EM-223	C CAPACITOR
	C 037	QCC11EM-223	C CAPACITOR
	C 038	QETC1CM-106ZM	E CAPACITOR
	C 039	QETC1CM-106ZM	E CAPACITOR
	C 040	QCF11HP-103	C CAPACITOR
	C 041	QETC1AM-227ZM	E CAPACITOR
	C 042	QCB1HK-331Y	C CAPACITOR
	C 043	QETC1HM-335ZM	E CAPACITOR
	C 045	QETB1AM-476	E. CAPACITOR
	C 046	QETC1HM-335ZM	E CAPACITOR
	C 047	QCC11EM-223	C CAPACITOR
	C 048	QFP31HJ-471ZM	PP. CAPACITOR
	C 049	QETC1HM-474ZM	E CAPACITOR
	C 050	QETC1HM-474ZM	E CAPACITOR
	C 051	QETC1EM-475ZM	E. CAPACITOR
	C 053	QCC11EM-103	C CAPACITOR
	C 054	QCC11EM-103	C CAPACITOR
	C 055	QETC1HM-474ZM	E CAPACITOR
	C 056	QETC1HM-474ZM	E CAPACITOR
	C 058	QCSB1HM-1R5Y	C CAPACITOR
	C 059	QCB1HK-101Y	C CAPACITOR
	C 060	QCC11EM-123	C CAPACITOR
	C 080	QCS11HJ-560	C. CAPACITOR
	C 081	QCS11HJ-150	C. CAPACITOR
	C 083	QCS11HJ-560	C. CAPACITOR
	D 003	MA165	SI DIODE
	D 004	MA346-TA5	VC DIODE
	D 007	MA165	SI DIODE
	D 008	MA165	SI DIODE
	D 009	MA165	SI DIODE
	IC 01	TA7358P(N)	IC
	IC 02	AN7222N	IC

△	REF.	PARTS NO.	PARTS NAME
	IC 03	AN7410N	IC
	L 001	V03105-029	OSC COIL
	L 002	VQF1B12-007	RF COIL
	L 003	VQL7T19-301	OSC COIL
	L 004	VQB010B-309	BAR ANTENA
	L 005	VQM7U01-301	OSC COIL
	L 007	VQS7U01-305	OSC COIL
	L 008	VQR7002-302	RF COIL
	L 009	V03047-6T	COIL
	L 010	VQP0012-100	INDUCTOR
	Q 001	2SC2668(O)E4	TRANSISTOR
	Q 002	2SC1740S(RS)-T	TRANSISTOR
	R 001	QRD161J-820	C. RESISTOR
	R 002	QRD161J-220	CARBON RESISTOR
	R 003	QRD161J-104	CARBON RESISTOR
	R 004	QRD161J-104	CARBON RESISTOR
	R 005	QRD161J-184	C RESISTOR
	R 006	QRD161J-471	CARBON RESISTOR
	R 007	QRD161J-561	C RESISTOR
	R 008	QRD161J-332	CARBON RESISTOR
	R 009	QRD161J-560	C. RESISTOR
	R 013	QRD161J-101	CARBON RESISTOR
	R 014	QRD161J-222	CARBON RESISTOR
	R 020	QRD161J-223	CARBON RESISTOR
	R 021	QRD161J-102	CARBON RESISTOR
	R 022	QRD161J-473	CARBON RESISTOR
	R 023	QRD161J-103	CARBON RESISTOR
	R 024	QRD161J-103	CARBON RESISTOR
	R 025	QRD161J-103	CARBON RESISTOR
	R 026	QRD161J-560	C. RESISTOR
	R 027	QRD161J-103	CARBON RESISTOR
	R 031	QRD161J-222	CARBON RESISTOR
	R 032	QRD161J-222	CARBON RESISTOR
	R 037	QRD161J-104	CARBON RESISTOR
	R 038	QRD161J-563	C RESISTOR
	R 080	QRD161J-334	CARBON RESISTOR
	R 081	QRD161J-563	C RESISTOR
	S 001	QSS8401-001	SLIDE SWITCH
	T 001	VQT7F12-111	IFT
	T 002	VQT7A21-105	IFT
	TC 05	QAT2002-001S	T. CAPACITOR
	TC 06	QAT2002-001S	T. CAPACITOR
	TC 09	QAT3722-200ZM	T CAPACITOR
	TC 10	QAT3722-200ZM	T CAPACITOR
	TC 11	QAT3620-100M	T CAPACITOR
	VC01-4	QAP1224-520VS	V CAPACITOR
	VR 01	QVZ3512-502	V. RESISTOR

■ CD Control P.C. Board:
 Drawing No. VMW2307
 BLOCK NO. 03

△	REF.	PARTS NO.	PARTS NAME
	C 502	QEK41CM-476	E CAPACITOR
	C 505	QCBB1HK-471Y	C CAPACITOR
	C 506	QCC11EM-223	C CAPACITOR
	C 507	QCS11HJ-680	C CAPACITOR
	C 508	QETC1AM-476ZN	E CAPACITOR
	C 509	QCS11HJ-680	C CAPACITOR
	C 510	QCSB1HK-2R2Y	C CAPACITOR
	C 511	QCC11EM-223	C CAPACITOR
	C 512	QCS11HJ-220	C CAPACITOR
	C 513	QCBB1HK-820Y	C CAPACITOR
	C 514	QCVB1CM-103Y	C CAPACITOR
	C 515	QCC11EM-473	C CAPACITOR
	C 516	QCS11HJ-470	C CAPACITOR
	C 517	QCBB1HK-151Y	C CAPACITOR
	C 518	QCBB1HK-101Y	C CAPACITOR
	C 519	QCS11HJ-330	C CAPACITOR
	C 520	QCXB1CM-222Y	C CAPACITOR
	C 521	QEK41CM-476	E CAPACITOR
	C 522	QCBB1HK-221Y	C CAPACITOR
	C 523	QCBB1HK-221Y	C CAPACITOR
	C 525	QER41EM-475	E CAPACITOR
	C 526	QETC1AM-476ZN	E CAPACITOR
	C 527	QEN61HM-105Z	NP.E.CAPACITOR
	C 528	QFV41HJ-223	FILM CAPACITOR
	C 529	QFV71HJ-273ZM	TF.CAPACITOR
	C 531	QCY41HK-822	C CAPACITOR
	C 535	QFV41HJ-224	TF CAPACITOR
	C 544	QCS11HJ-100	C CAPACITOR
	C 545	QCS11HJ-100	C CAPACITOR
	C 547	QCC11EM-473	C CAPACITOR
	C 548	QETC1AM-476ZN	E CAPACITOR
	C 549	QCC11EM-473	C CAPACITOR
	C 550	QCBB1HK-331Y	C CAPACITOR
	C 551	QETC1AM-476ZN	E CAPACITOR
	C 552	QETC1AM-476ZN	E CAPACITOR
	C 553	QCY41HK-122	C CAPACITOR
	C 554	QETC1EM-106ZN	E CAPACITOR
	C 555	QCY41HK-122	C CAPACITOR
	C 556	QETC1AM-476ZN	E CAPACITOR
	C 557	QCBB1HK-331Y	C CAPACITOR
	C 563	QFV41HJ-123	FILM CAPACITOR
	C 587	QCVB1CM-103Y	C CAPACITOR
	C 595	QETC1AM-107ZN	E CAPACITOR
	C 604	QETC1HM-475ZN	E CAPACITOR
	C 605	QETC1HM-475ZN	E CAPACITOR
	C 606	QCXB1CM-562Y	C CAPACITOR
	C 607	QCXB1CM-562Y	C CAPACITOR
	C 608	QCXB1CM-682Y	C CAPACITOR
	C 609	QCXB1CM-682Y	C CAPACITOR
	C 610	QCS11HJ-680	C CAPACITOR
	C 611	QCS11HJ-680	C CAPACITOR
	C 612	QETC1HM-105ZN	E CAPACITOR
	C 613	QETC1HM-105ZN	E CAPACITOR
	C 614	QCC11EM-123	C CAPACITOR
	C 615	QCC11EM-123	C CAPACITOR
	C 616	QETC1AM-107ZN	E CAPACITOR
	C 617	QETC1AM-107ZN	E CAPACITOR
	C 618	QCC11EM-223	C CAPACITOR
	C 620	QETC1AM-107ZN	E CAPACITOR
	C 621	QETC1AM-108ZN	E CAPACITOR
	C 623	QETC1AM-476ZN	E CAPACITOR
	CN501	VMC0075-010N	CONNECTOR
	CN502	VMC0075-006N	CONNECTOR
	CN503	VMC0075-004N	CONNECTOR
	CN504	VMC0163-013	CONNECTOR

△	REF.	PARTS NO.	PARTS NAME
	D 603	MA165	SI DIODE
	D 610	HZSS.6EB3	Z DIODE
	FB 02	VQZ0048-006	EMI FILTER
	FB 03	VQZ0048-006	EMI FILTER
	FB 04	VQZ0048-006	EMI FILTER
	IC501	MC13501M	IC
	IC502	NJM3403D-C	IC
	IC503	BA6294	IC
	IC504	BA6294	IC
	IC602	TC9201BF	IC
	IC603	TC9200BF	IC
	IC604	CXK5816PS-15L	IC
	IC605	TD6710AF	IC
	IC607	XRA15218N	IC
	L 703	VQP0028-100Z	INDUCTOR
	L 704	T41572-001	CHOKE COIL
	PS501	PTH61G30BD2R2N	POSISTER
	Q 501	2SA1175(HFE)	TRANSISTOR
	Q 503	2SC2785(HFE)	TRANSISTOR
	Q 504	2SC2785(HFE)	TRANSISTOR
	Q 505	2SA1175(HFE)	TRANSISTOR
	Q 614	2SD1302(S,T)	TRANSISTOR
	R 501	QRD161J-184	CARBON RESISTOR
	R 502	QRD161J-154	CARBON RESISTOR
	R 503	QRD161J-682	CARBON RESISTOR
	R 504	QRD161J-472	CARBON RESISTOR
	R 505	QRD161J-102	CARBON RESISTOR
	R 506	QRD161J-681	CARBON RESISTOR
	R 507	QRD161J-104	CARBON RESISTOR
	R 508	QRD161J-273	CARBON RESISTOR
	R 509	QRD161J-222	CARBON RESISTOR
	R 510	QRD161J-103	CARBON RESISTOR
	R 511	QRD161J-103	CARBON RESISTOR
	R 512	QRD161J-123	CARBON RESISTOR
	R 513	QRD161J-103	CARBON RESISTOR
	R 514	QRD161J-224	CARBON RESISTOR
	R 515	QRD161J-333	CARBON RESISTOR
	R 516	QRD161J-153	CARBON RESISTOR
	R 517	QRD161J-822	CARBON RESISTOR
	R 519	QRD161J-823	CARBON RESISTOR
	R 520	QRV141F-3302AY	CMF RESISTOR
	R 521	QRD161J-823	CARBON RESISTOR
	R 522	QRD161J-102	CARBON RESISTOR
	R 523	QRD161J-562	CARBON RESISTOR
	R 524	QRD161J-152	CARBON RESISTOR
	R 525	QRD161J-273	CARBON RESISTOR
	R 526	QRD161J-682	CARBON RESISTOR
	R 527	QRD161J-564	CARBON RESISTOR
	R 528	QRD161J-472	CARBON RESISTOR
	R 529	QRD161J-103	CARBON RESISTOR
	R 530	QRD161J-103	CARBON RESISTOR
	R 531	QRD161J-102	CARBON RESISTOR
	R 532	QRD161J-153	CARBON RESISTOR
	R 533	QRD161J-103	CARBON RESISTOR
	R 534	QRD161J-821	CARBON RESISTOR
	R 535	QRD161J-272	CARBON RESISTOR
	R 536	QRD161J-104	CARBON RESISTOR
	R 537	QRD161J-563	CARBON RESISTOR
	R 538	QRD161J-153	CARBON RESISTOR
	R 539	QRD161J-333	CARBON RESISTOR
	R 540	QRD161J-562	CARBON RESISTOR
	R 541	QRD161J-104	CARBON RESISTOR
	R 542	QRD161J-273	CARBON RESISTOR
	R 544	QRD161J-392	CARBON RESISTOR
	R 545	QRD161J-103	CARBON RESISTOR

△	REF.	PARTS NO.	PARTS NAME
R	546	QRD161J-104	CARBON RESISTOR
R	547	QRD161J-473	CARBON RESISTOR
R	548	QRD161J-683	CARBON RESISTOR
R	549	QRD161J-181	CARBON RESISTOR
R	550	QRD161J-103	CARBON RESISTOR
R	559	QRD161J-103	CARBON RESISTOR
R	560	QRD161J-103	CARBON RESISTOR
R	565	QRD161J-683	CARBON RESISTOR
R	566	QRD161J-181	CARBON RESISTOR
R	570	QRD161J-103	CARBON RESISTOR
R	573	QRD161J-183	CARBON RESISTOR
R	590	QRD161J-102	CARBON RESISTOR
R	640	QRD161J-821	CARBON RESISTOR
R	641	QRD161J-680	CARBON RESISTOR
R	642	QRD161J-153	CARBON RESISTOR
R	643	QRD161J-153	CARBON RESISTOR
R	645	QRD161J-151	CARBON RESISTOR
R	647	QRD161J-102	CARBON RESISTOR
R	649	QRD161J-102	CARBON RESISTOR
R	660	QRD161J-272	CARBON RESISTOR
R	661	QRD161J-272	CARBON RESISTOR
R	662	QRD161J-332	CARBON RESISTOR
R	663	QRD161J-332	CARBON RESISTOR
R	664	QRD161J-103	CARBON RESISTOR
R	665	QRD161J-103	CARBON RESISTOR
R	666	QRD161J-103	CARBON RESISTOR
R	667	QRD161J-103	CARBON RESISTOR
R	668	QRD161J-332	CARBON RESISTOR
R	669	QRD161J-332	CARBON RESISTOR
R	672	QRD161J-122	CARBON RESISTOR
R	673	QRD161J-122	CARBON RESISTOR
R	676	QRV141F-8202AY	CMF RESISTOR
R	677	QRD161J-333	CARBON RESISTOR
R	678	QRV141F-3302AY	CMF RESISTOR
R	681	QRV141F-8202AY	CMF RESISTOR
R	682	QRV141F-3302AY	CMF RESISTOR
R	684	QRV141F-8202AY	CMF RESISTOR
R	685	QRD161J-473	CARBON RESISTOR
R	686	QRV141F-3302AY	CMF RESISTOR
R	687	QRD161J-473	CARBON RESISTOR
R	688	QRD161J-473	CARBON RESISTOR
R	690	PTH61G30BD2R2N	POSISTER
R	691	QRV141F-8202AY	CMF RESISTOR
R	692	QRD161J-823	CARBON RESISTOR
R	695	QRV141F-8202AY	CMF RESISTOR
R	696	QRD161J-183	CARBON RESISTOR
R	697	QRV141F-3302AY	CMF RESISTOR
R	698	QRD161J-682	CARBON RESISTOR
VR	501	QVZ3523-503AZ	V RESISTOR
X	601	VCX5016-934V	CRYSTAL

△	REF.	PARTS NO.	PARTS NAME
C	706	QCVB1CM-103Y	C CAPACITOR
C	707	QCBB1HK-102Y	C CAPACITOR
C	708	QCBB1HK-102Y	C CAPACITOR
C	709	QCBB1HK-221Y	C CAPACITOR
C	751	QER41AM-107	E CAPACITOR
C	752	QFV41HJ-683	TF CAPACITOR
C	753	QFV41HJ-683	TF CAPACITOR
CN	701	VMC0163-013	CONNECTOR
CN	711	VMC0075-011N	CONNECTOR
CN	712	VMC0075-006N	CONNECTOR
CN	771	VMC0075-R02N	CONNECTOR
D	701	MA165	SI DIODE
D	702	MA165	SI DIODE
D	703	MA165	SI DIODE
D	704	MA165	SI DIODE
D	711	MA165	SI DIODE
D	712	MA165	SI DIODE
IC	701	UPD75312GF-095	CPU
IC	702	MN1280(R)	IC
IC	751	TA8409S	IC
L	701	T41572-001	CHOKE COIL
L	CD02	VGL1097-001	LCD
Q	751,	DTC143ZSTP	TRANSISTOR
R	701	QRD161J-334	CARBON RESISTOR
R	721	QRD161J-473	CARBON RESISTOR
R	722	QRD161J-473	CARBON RESISTOR
R	723	QRD161J-473	CARBON RESISTOR
R	724	QRD161J-473	CARBON RESISTOR
R	731	QRD161J-102	CARBON RESISTOR
R	732	QRD161J-102	CARBON RESISTOR
R	733	QRD161J-102	CARBON RESISTOR
R	734	QRD161J-102	CARBON RESISTOR
R	735	QRD161J-102	CARBON RESISTOR
R	736	QRD161J-102	CARBON RESISTOR
R	737	QRD161J-102	CARBON RESISTOR
R	738	QRD161J-102	CARBON RESISTOR
R	739	QRD161J-102	CARBON RESISTOR
R	741	QRD161J-272	CARBON RESISTOR
R	742	QRD161J-272	CARBON RESISTOR
R	743	QRD161J-102	CARBON RESISTOR
R	744	QRD161J-102	CARBON RESISTOR
R	745	QRD161J-102	CARBON RESISTOR
R	746	QRD161J-102	CARBON RESISTOR
R	751	QRD121J-2R2	CARBON RESISTOR
R	752	QRD161J-822	CARBON RESISTOR
R	753	QRD161J-103	CARBON RESISTOR
S	701	QSQ4H11-V02Z	TACT SW
S	702	QSQ4H11-V02Z	TACT SW
S	703	QSQ4H11-V02Z	TACT SW
S	704	QSQ4H11-V02Z	TACT SW
S	705	QSQ4H11-V02Z	TACT SW
S	706	QSQ4H11-V02Z	TACT SW
S	707	QSQ4H11-V02Z	TACT SW
S	708	QSQ4H11-V02Z	TACT SW
S	709	QSQ4H11-V02Z	TACT SW
S	710	QSQ4H11-V02Z	TACT SW
S	711	QSP4K11-V01	PUSH SW
S	751	VSH1153-001	SWITCH
S	752	VSH1153-001	SWITCH
X	701	EFO-GC4194T4	CERAMIC RESONAT
X	702	VCX5000-001	CRYSTAL

■ SYSTEM-CPU/CD Operation Key Switch
P.C. Board etc.: Drawing No. VMW1261
BLOCK NO.

△	REF.	PARTS NO.	PARTS NAME
C	701	QER41AM-107	E CAPACITOR
C	702	VCPO009-105Z	C CAPACITOR
C	703	QCS11HJ-100	C CAPACITOR
C	704	QCS11HJ-100	C CAPACITOR
C	705	QCC11EM-103	C CAPACITOR

13 Illustration of Packing and Packing Parts List

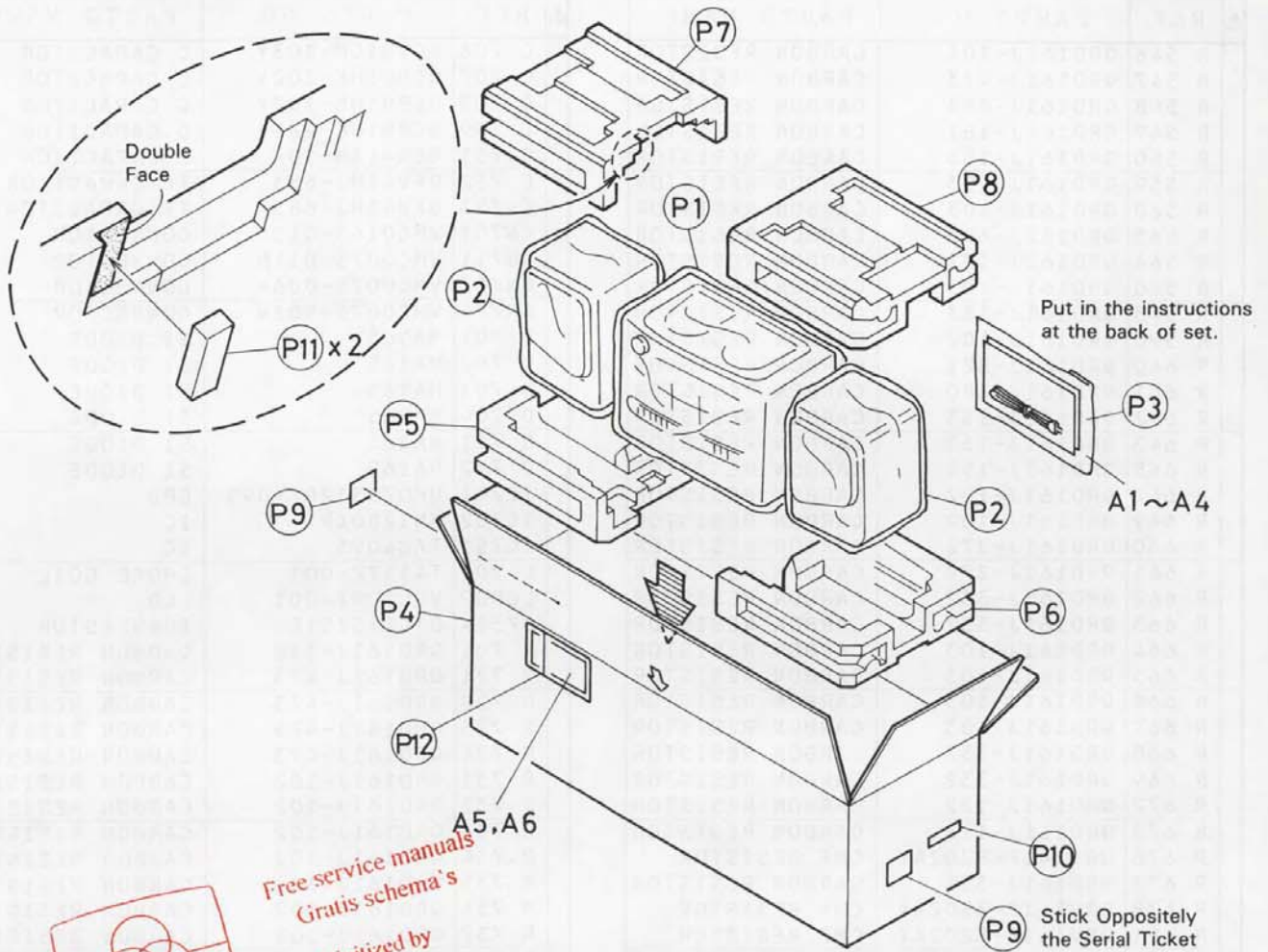

Fig. 13-1

■ Packing Parts List

BLOCK NO. M8MM

△	REF.	PARTS NO.	PARTS NAME	REMARKS	QTY
	P1	E300196-031B	Envelope	For Unit	1
	P2	VPE3005-063	Poly Bag	For Speaker Box	2
	P3	VPE3005-007	Poly Bag	For Instructions	1
	P4	VPC7056-002	Carton		1
	P5	VPH1560-001	Cushion (B, L)	For Bottom Left	1
	P6	VPH1560-002	Cushion (B, R)	For Bottom Right	1
	P7	VPH1561-001	Cushion (U, L)	For Upper Left	1
	P8	VPH1561-002	Cushion (U, R)	For Upper Right	1
	P9	VND3044-003	Serial Ticket	Blue Label: PC-XT3 E	1
		VND3044-004	"	Green Label: PC-XT3 B	1
		VND3044-005	"	Red Label: PC-XT3 G	1
	P10	VND3025-143	EAN Label		1
	P11	VPH4123-001	Pad		2
	P12	E66416-003	Envelope	For Warranty Card	1

14 Accessories

BLOCK NO.

△	REF.	PARTS NO.	PARTS NAME	REMARKS	QTY
△	A1	QMP3950-183	POWER CORD		1
	A2	VNN7056-211	INSTRUCTIONS	PC-XT3 B/E/G	1
		VNN7056-441	"	PC-XT3 E	1
	A3	BT4220-001	WARRANTY CARD	PC-XT3 E	1
	A4	VNC1200-054	CAUTION SHEET	#1 ~ 1500	1
	A5	BT-20114	WARRANTY CARD	PC-XT3 E	1
	A6	BT-20066A	WARRANTY CARD	PC-XT3 G	1
		PU36158	FTZ INFORMATION SHEET	PC-XT3 G	1

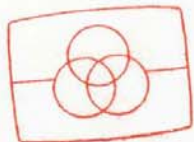

Free service manuals
Gratis schema's
Digitized by

www.freeservicemanuals.info

JVC

VICTOR COMPANY OF JAPAN, LIMITED
PERSONAL AUDIO PRODUCTS DIVISION 10-1, 1-chome, Ohwatari-machi, Maebashi-city, Japan